

ПАСПОРТ ИЗДЕЛИЯ

Пластиковый сарай

MODERNIST J

11 м²



BLACK FOX™

garden sheds

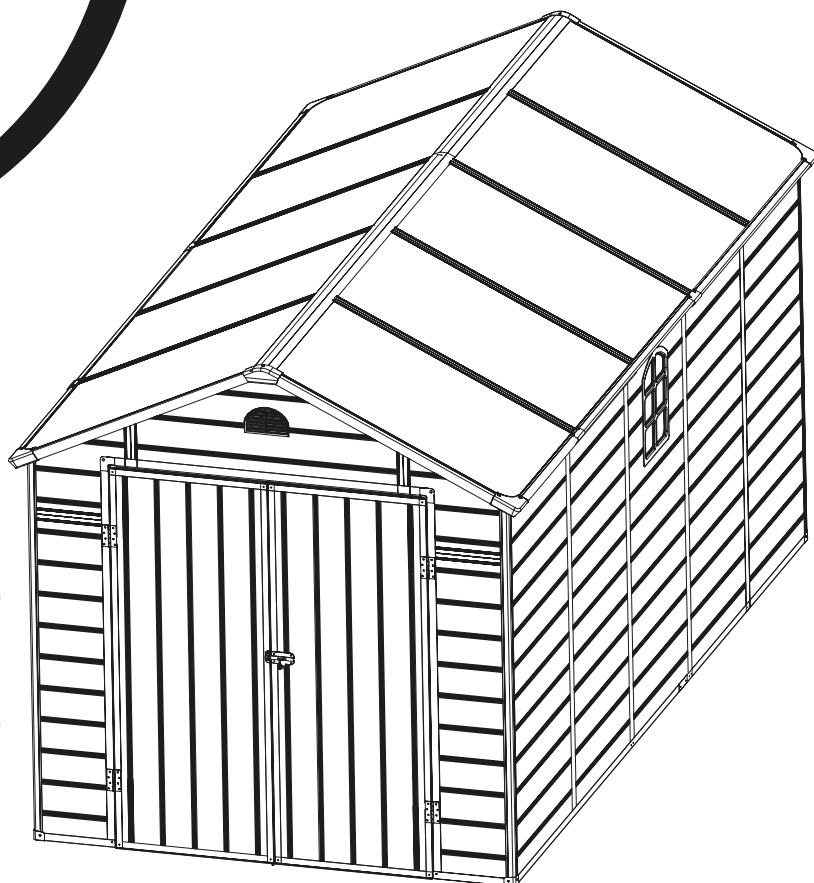

242x456x239 см

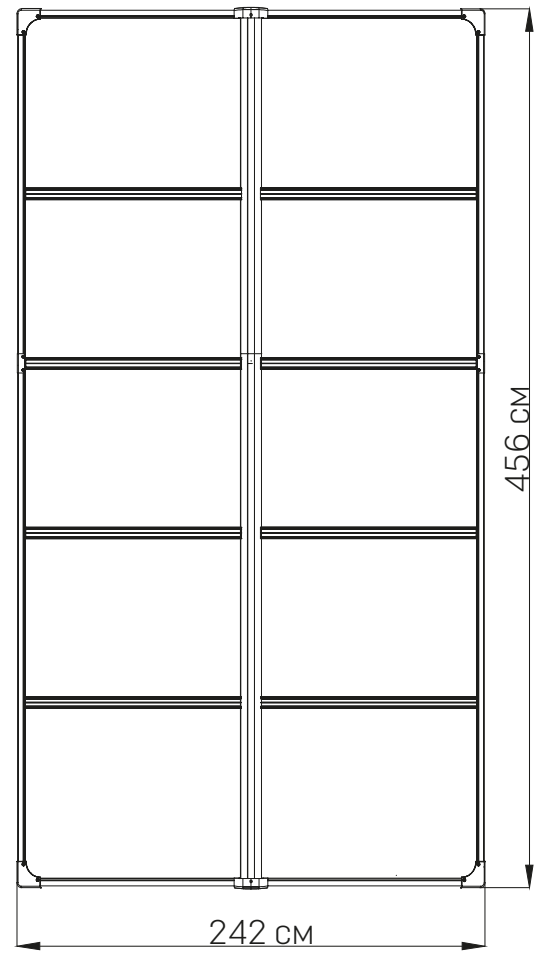
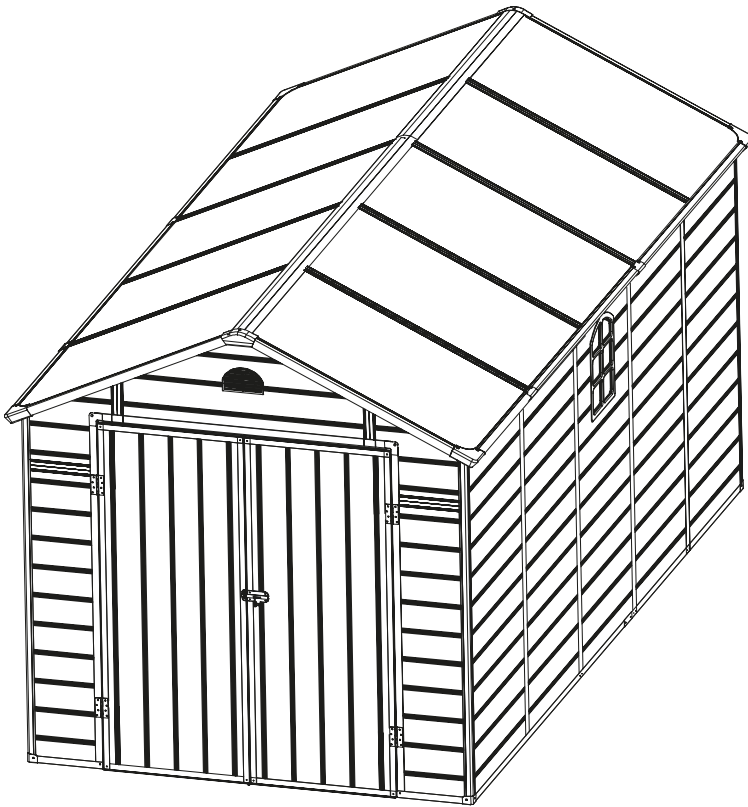
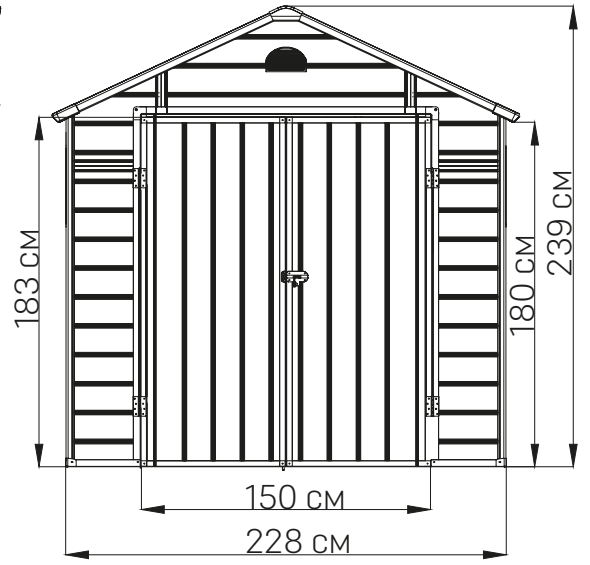
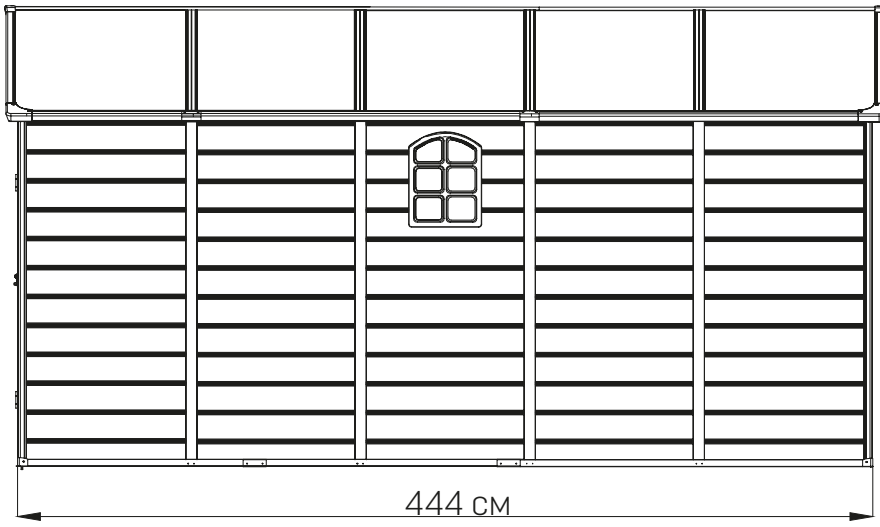

ПЛАСТИКОВЫЙ САРАЙ – комплексное решение для хранения вещей. Всепогодный прочный ПВХ не подвержен появлению вмятин, ржавчины, гнили или плесени и не нуждается в окраске.

ХАРАКТЕРИСТИКИ

- Двухслойные стеновые панели;
- Материал изготовления – PP;
- Каркас – PP трубы, усиленные элементами из оцинкованной стали;
- Пол в комплекте;
- Стальные петли для замка;
- Прозрачное окно из цельного небьющегося поликарбоната;
- Дверные щеколды в комплекте.

РАЗМЕР

Хранилище	Площадь	11 кв. м
	Объем	18,4 куб. м
	Размер основания	228x444см
	Размер по крыше	242x456x239 см
Дверной проем		150x180 см
Количество упаковок		3 шт



ВНИМАНИЕ! Пожалуйста, полностью прочитайте данную инструкцию перед сборкой и эксплуатацией изделия.

БЕЗОПАСНОСТЬ И МЕРЫ ПРЕДОСТОРОЖНОСТИ

1. Выберите площадку, на которой достаточно рабочего пространства вокруг хранилища

2. **⚠️ ВНИМАНИЕ! ПЛОЩАДКА ДЛЯ УСТАНОВКИ САРАЯ ДОЛЖНА БЫТЬ РОВНОЙ.** Убедитесь в том, что рама-основание лежит ровно на земле. Если поверхность почвы неровная, снимите дерн и прочий мусор и разровняйте ее плоской лопатой.

3. Определитесь с фундаментом постройки и системой крепления.

⚠️ ВНИМАНИЕ! САРАЙ ДОЛЖЕН БЫТЬ УСТАНОВЛЕН НА ПРОЧНОМ ОСНОВАНИИ ФУНДАМЕНТА.

Для подходящего основания пола рекомендуются бетонная площадка или ровный деревянный настил. Убедитесь, что основание является твердым и выровненным и обеспечен дренаж от площадки. Базовая основа должна быть не менее чем на 100 мм больше, чем основание сарая. Пожалуйста, обратитесь к разделу Характеристики данной инструкции для определения наружных размеров сарая. Производитель не несет ответственности за выбор и строительство фундамента.

Для бетонирования основания подготовьте выровненную поверхность и для прочности выложите ее слоем щебня. Затем она должна быть залита бетоном толщиной от 100 мм до 125 мм. Затем основанию нужно дать тщательно высохнуть в течение не менее 48 часов.

4. Ваш сарай должен быть надежно закреплен на бетонном основании, чтобы защитить его от повреждений при сильном ветре

5. Для правильной сборки тщательно следуйте всем указаниям по сборке и размерам, изложенным в инструкции.

6. Ознакомьтесь со списком деталей в инструкции. Разделите содержимое коробки по номерам деталей и сверьтесь со списком. Убедитесь, что все детали есть в наличии, прежде чем приступить к сборке.

7. Соблюдайте безопасность: выполняйте инструкции по технике безопасности и избегайте травм.

8. Всегда надевайте рабочие перчатки, одежду с длинным рукавом и защитные очки во время сборки сарая. Некоторые части сарая содержат острые края и могут привести к травме.

9. Будьте осторожны с инструментами, используемыми для сборки. Ознакомьтесь с правилами использования инструментов и техникой безопасности при работе с ними.

10. Дети и домашние животные должны находиться подальше от места сборки, чтобы избежать любых отвлекающих ситуаций и несчастных случаев.

11. При использовании лестницы убедитесь, что она установлена на ровной поверхности, полностью открыта и с защелкой безопасности на месте. Никогда не переносите полностью вес на крышу или любую часть сарая.

12. Не собирайте сарай в ветреную погоду. Панели могут быть сбиты ветром, что сделает рабочую площадку опасной.

13. Не используйте любую часть сарая в качестве средства личной поддержки при присоединении компонентов в процессе сборки.

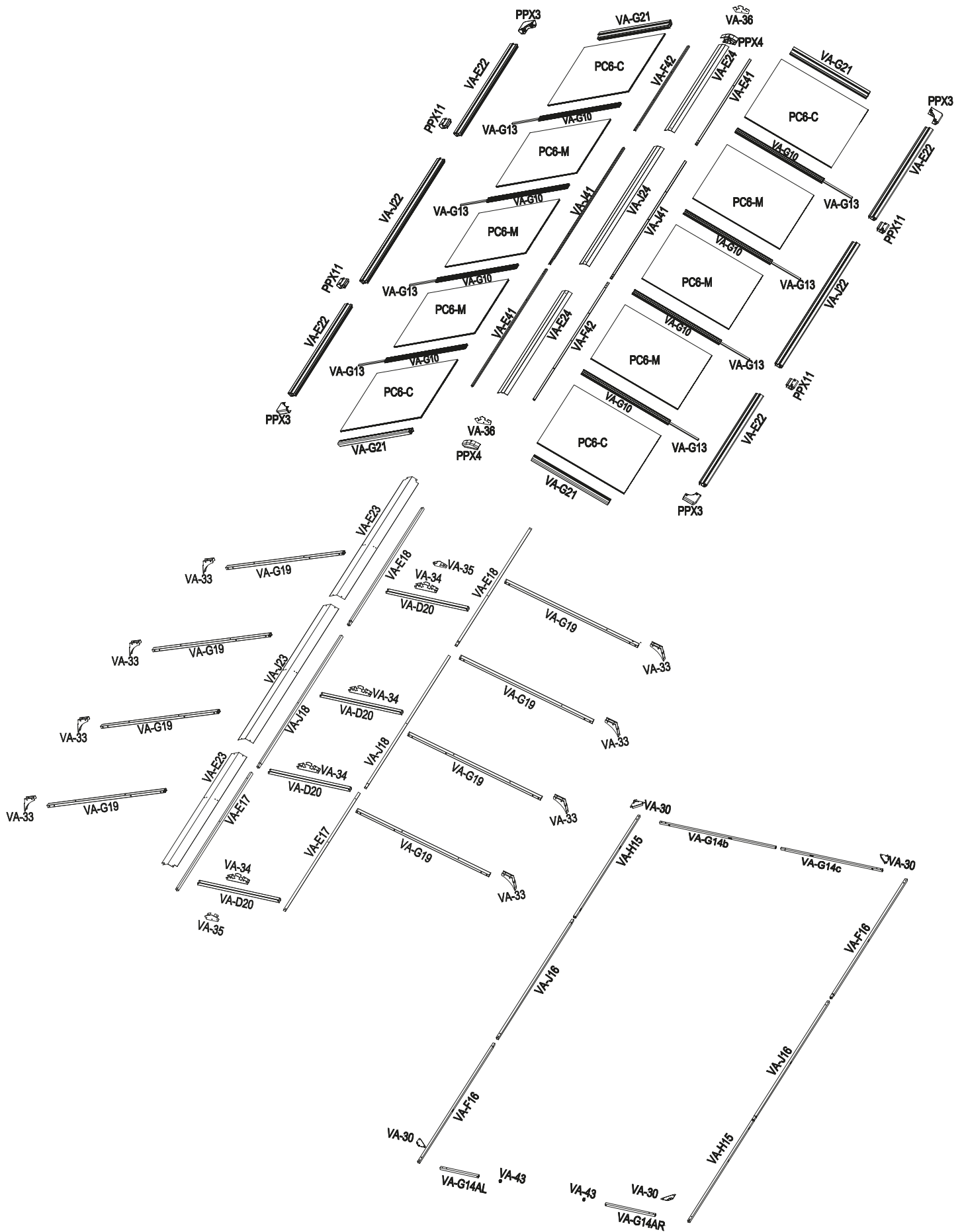

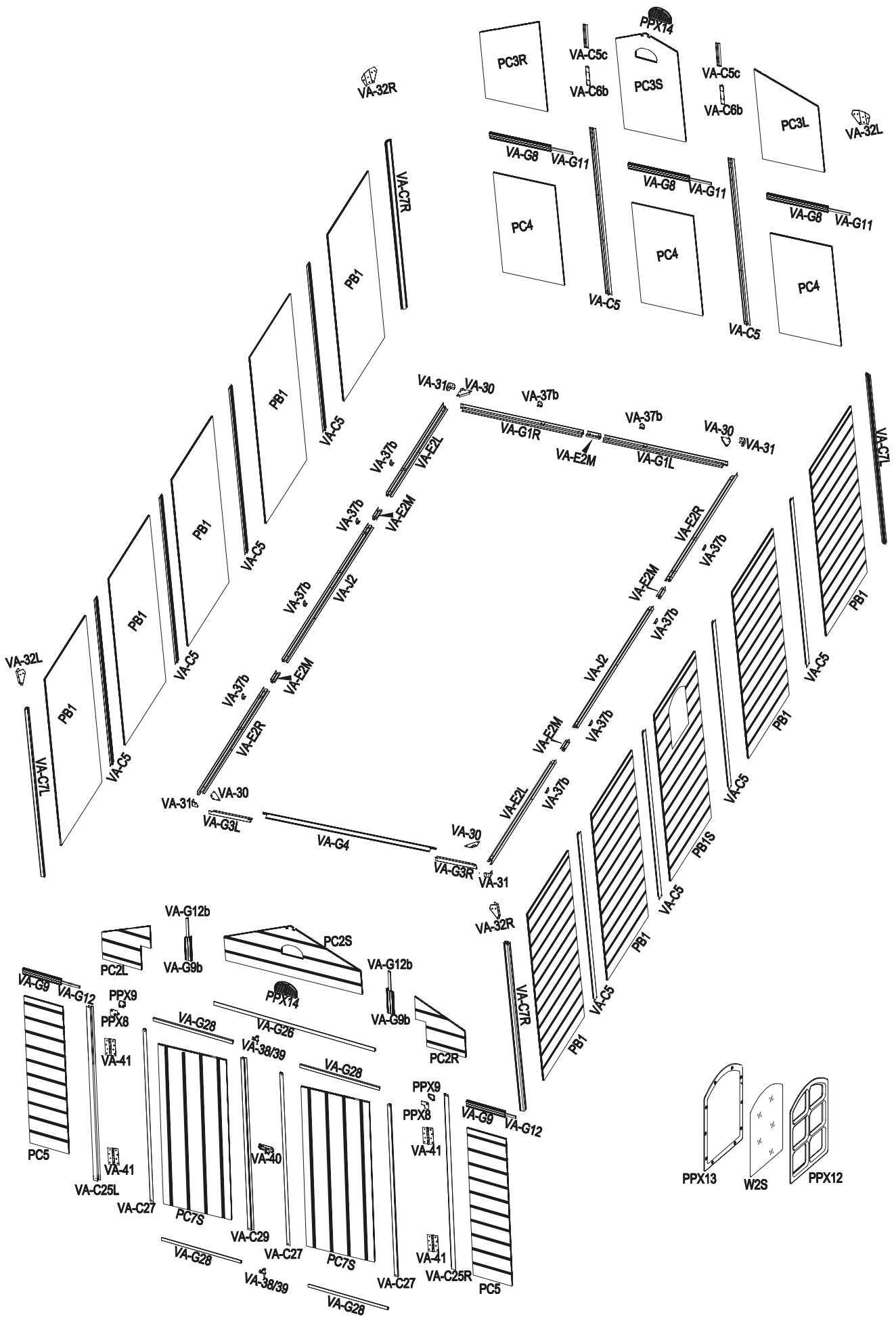

СПИСОК ДЕТАЛЕЙ

VA-G1L	1132 мм	x1	3/3
VA-G1R	1132 мм	x1	3/3
VA-J2	1760 мм	x2	3/3
VA-E2R	1330 мм	x2	3/3
VA-E2L	1330 мм	x2	3/3
VA-G3R	377 мм	x1	3/3
VA-G3L	377 мм	x1	3/3
VA-E2M	120 мм	x5	3/3
VA-G4	1588 мм	x1	3/3
VA-30		x8	2/3
VA-31		x4	2/3
VA-37b		x10	2/3

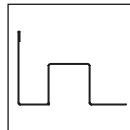

VA-G1L
VA-G1R
VA-J2
VA-E2R
VA-E2L
VA-G3R
VA-G3L

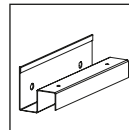

VA-E2M

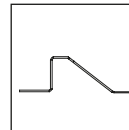

VA-G4

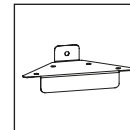

VA-30

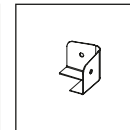

VA-31

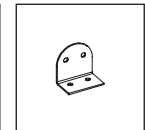

VA-37b

PB1	876X1840 мм	x9	1/3
PB1S	876X1840 мм	x1	1/3
PC2S	1270X542 мм	x1	2/3
PC2L	461X492 мм	x1	2/3
PC2R	461X492 мм	x1	2/3
PC3L	743X1072 мм	x1	1/3
PC3R	743X1072 мм	x1	1/3
PC3S	743x1248 мм	x1	2/3
PC4	743x1100 мм	x3	2/3
PC5	365x1548 мм	x2	1/3
VA-C7R	1860 мм	x2	1/3
VA-C7L	1860 мм	x2	1/3
VA-C5	1840 мм	x10	3/3
VA-C5c	365 мм	x2	3/3
VA-C6b	200 мм	x2	3/3
PPX12		x1	2/3
W2S		x1	2/3
PPX13		x1	2/3
VA-G8	738 мм	x3	2/3
VA-G9	360 мм	x2	2/3
VA-G9b	254 мм	x2	2/3
VA-G11	740 мм	x3	3/3
VA-G12	362 мм	x2	3/3
VA-G12b	225 мм	x2	3/3
VA-G14b	1200 мм	x1	3/3
VA-G14c	1052 мм	x1	3/3
VA-G14AL	345 мм	x1	3/3
VA-G14AR	345 мм	x1	3/3
VA-H15	970 мм	x2	3/3
VA-F16	1678мм	x2	3/3
VA-J16	1805 мм	x2	3/3
VA-E17	977 мм	x2	3/3
VA-E18	1745 мм	x2	3/3
VA-J18	1805 мм	x2	3/3
VA-G19	1181 мм	x8	3/3
VA-D20	725 мм	x4	3/3
VA-33		x8	3/3
VA-34		x4	3/3
VA-E23	1348 мм	x2	3/3
VA-J23	1780 мм	x1	3/3
VA-36		x2	2/3
VA-32R		x2	2/3
VA-32L		x2	2/3
VA-35		x2	2/3
PPX14		x2	2/3
PPX8		x2	2/3
PPX9		x2	2/3
VA-43		x2	2/3

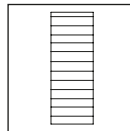
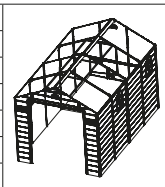

PB1

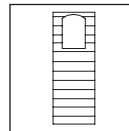

PB1S

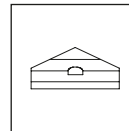

PC2S

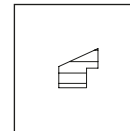

PC2L

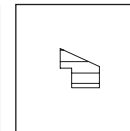

PC2R

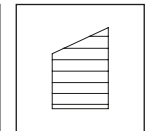

PC3L

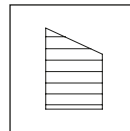

PC3R

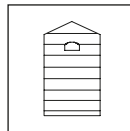

PC3S

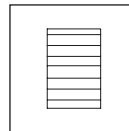

PC4

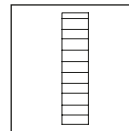

PC5

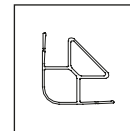

VA-C7R
VA-C7L

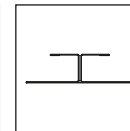

VA-C5
VA-C5c

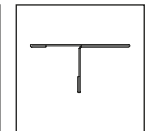

VA-C6b

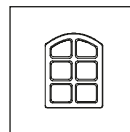

PPX12

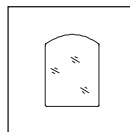

W2S

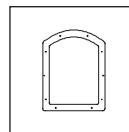

PPX13

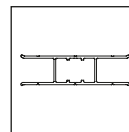

VA-G8
VA-G9
VA-G9b

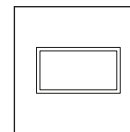

VA-G11
VA-G12
VA-G12b

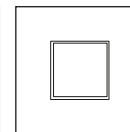

VA-G14b
VA-G14c
VA-G14AL
VA-G14AR

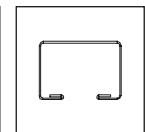

VA-G19

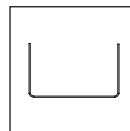

VA-D20

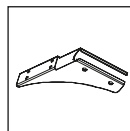

VA-33

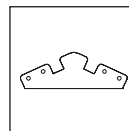

VA-34

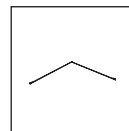

VA-E23

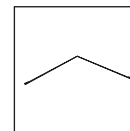

VA-J23

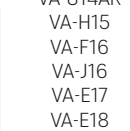

VA-H15
VA-F16
VA-J16
VA-E17
VA-E18
VA-J18

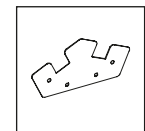

VA-36

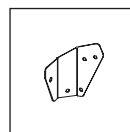

VA-32R

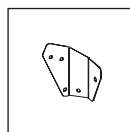

VA-32L

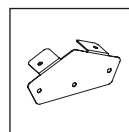

VA-35

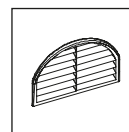

PPX14

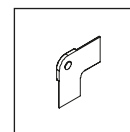

PPX8

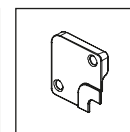

PPX9

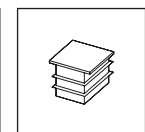

VA-43

VA-C25R	1830 мм	x1	3/3
VA-C25L	1830 мм	x1	3/3
VA-G26	1508 мм	x1	3/3
VA-C27	1812 мм	x3	3/3
VA-G28	747 мм	x4	3/3
VA-C29	1812 мм	x1	3/3
PC7S	1810X746 мм	x2	1/3

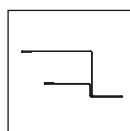
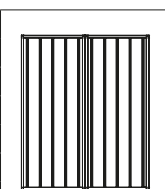

VA-C25R
VA-C25L
VA-G26

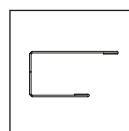

VA-C27
VA-G28

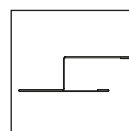

VA-C29

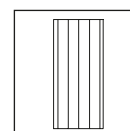

PC7S

СПИСОК ДЕТАЛЕЙ

PC6-C	1285X920 мм	x4	2/3
PC6-M	1285X856 мм	x6	2/3
VA-G10	1285 мм	x8	2/3
VA-G13	1285 мм	x8	3/3
VA-G21	1165 мм	x4	2/3
VA-E22	1282мм	x4	3/3
VA-J22	1740 мм	x2	3/3
VA-E24	1440 мм	x2	3/3
VA-J24	1861 мм	x1	3/3
VA-E41	983 мм	x2	3/3
VA-F42	1862 мм	x2	3/3
VA-J41	1862 мм	x2	3/3
PPX3		x4	2/3
PPX4		x2	2/3
PPX11		x4	2/3

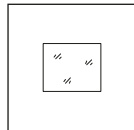
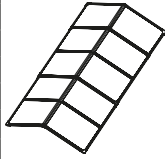

PC6-C

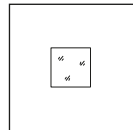

PC6-M

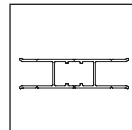

VA-G10

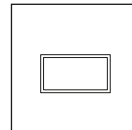

VA-G13

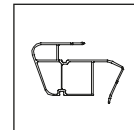

VA-G21
VA-E22
VA-J22

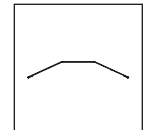

VA-E24
VA-J24

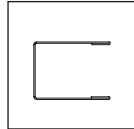

VA-E41
VA-F42
VA-J41

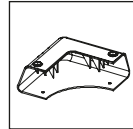

PPX3

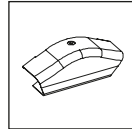

PPX4

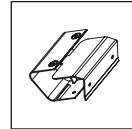

PPX11

VA-41		x4	2/3
VA-38a		x2	2/3
VA-38b		x2	2/3
VA-39		x2	2/3
VA-40		x1	2/3
CN-A33		x2	2/3
PA01		x3	2/3
VA-J44	ST4.2x13 мм	x510	2/3
VA-J45	ST4.2x19 мм	x137	2/3
VA-J46	ST4.2x13 мм	x83	2/3
VA-J47	ST4.2x19 мм	x4	2/3
VA-J48	ST6.0x40 мм	x9	2/3
VA-J49	ST4.2x13 мм	x26	2/3
VA-J50	M6x40 мм	x40	2/3
VA-51		x1	2/3
VA-J52		x4	2/3
VA-53		x4	2/3
VA-55		x3	2/3
VA-DB06	880x1102 мм	x2	2/3
VA-DB07	735x1740 мм	x6	1/3

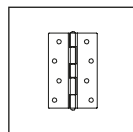

VA-41

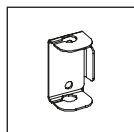

VA-38a

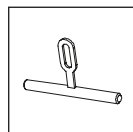

VA-38b

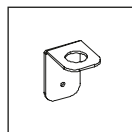

VA-39

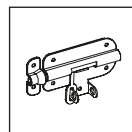

VA-40

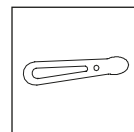

CN-A33

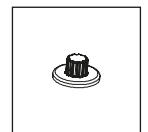

PA01

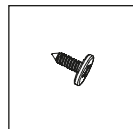

VA-J44

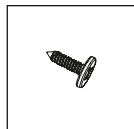

VA-J45

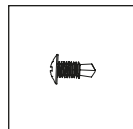

VA-J46

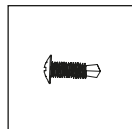

VA-J47

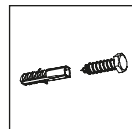

VA-J48

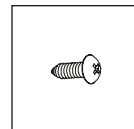

VA-J49

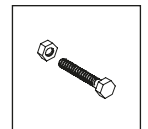

VA-J50

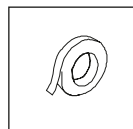

VA-51

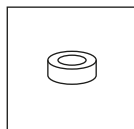

VA-J52

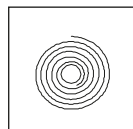

VA-53



VA-55

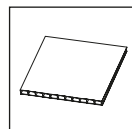

VA-DB06
VA-DB07

ПОРЯДОК СБОРКИ

⚠ ВНИМАНИЕ! Перед началом установки, пожалуйста, обратитесь к разделу Безопасность и меры предосторожности.

1. Для сборки изделия Вам понадобятся:



2. Ориентировочное время сборки:



3. Количество сборщиков:



СХЕМА СБОРКИ ИЗДЕЛИЯ

1								
	VA-E2L [x2] 1330 MM	VA-E2R [x2] 1330 MM	VA-J2 [x2] 1760 MM	VA-G1R [x1] 1132 MM	VA-G1L [x1] 1132 MM	VA-E2M [x5] 120 MM	VA-J44 [x10] 13 MM	



2								
	VA-G3L [x1] 377 MM	VA-G3R [x1] 377 MM	VA-G4 [x1] 1588 MM	VA-J44 [x4] 13 MM				

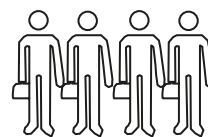
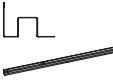
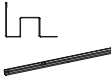
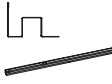
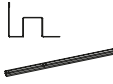
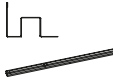
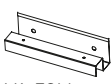
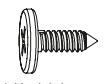
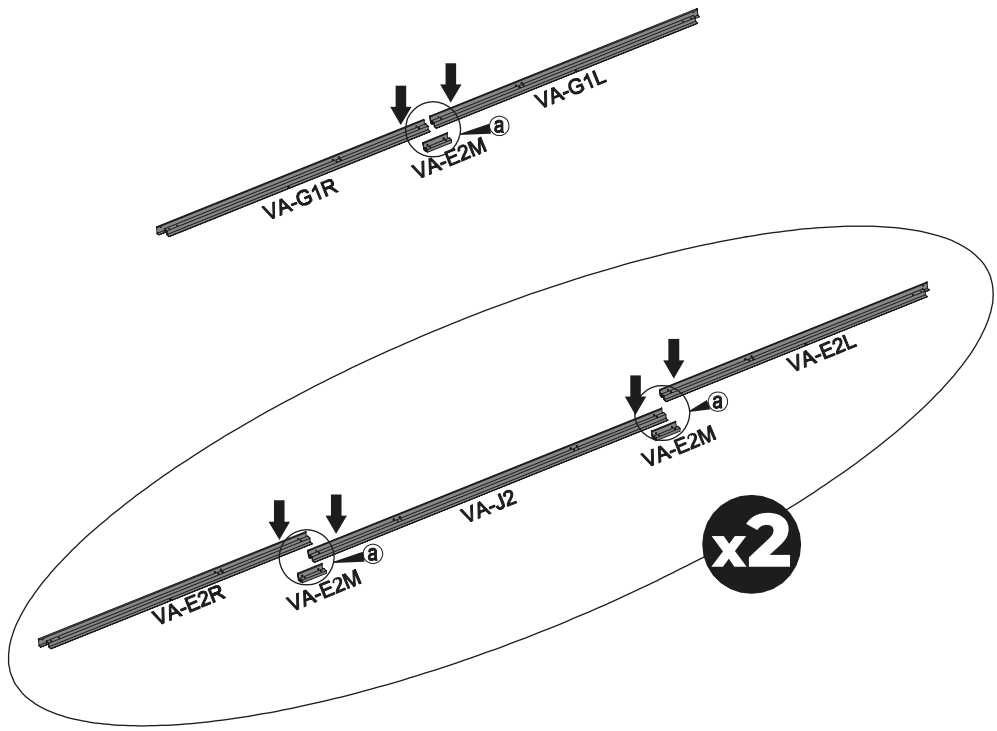
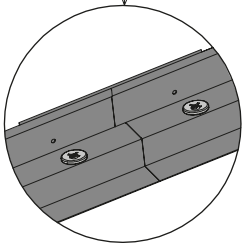
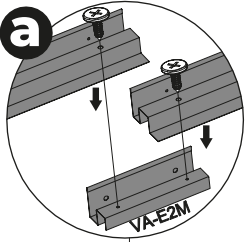
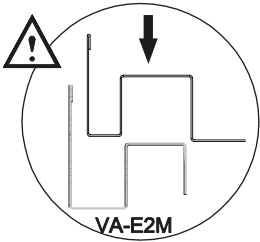
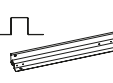
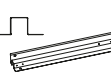
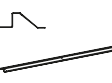
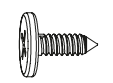
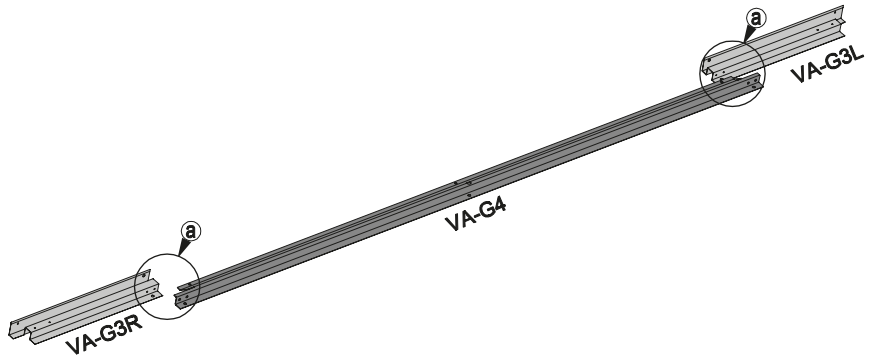
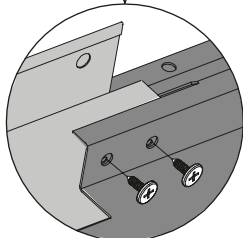
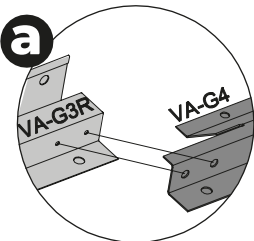
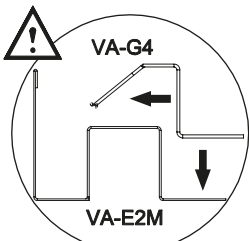

3

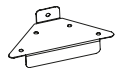

VA-30 [x4]



VA-J44 [x16]
13 MM

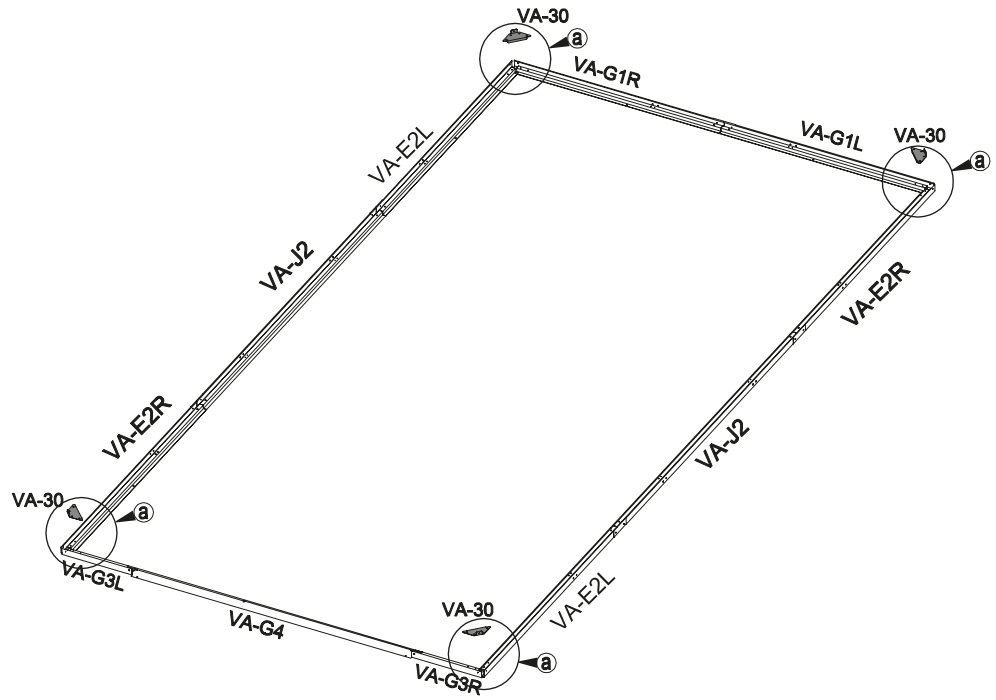
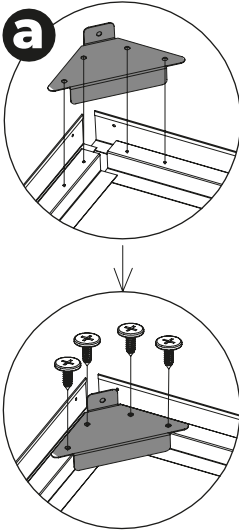





4

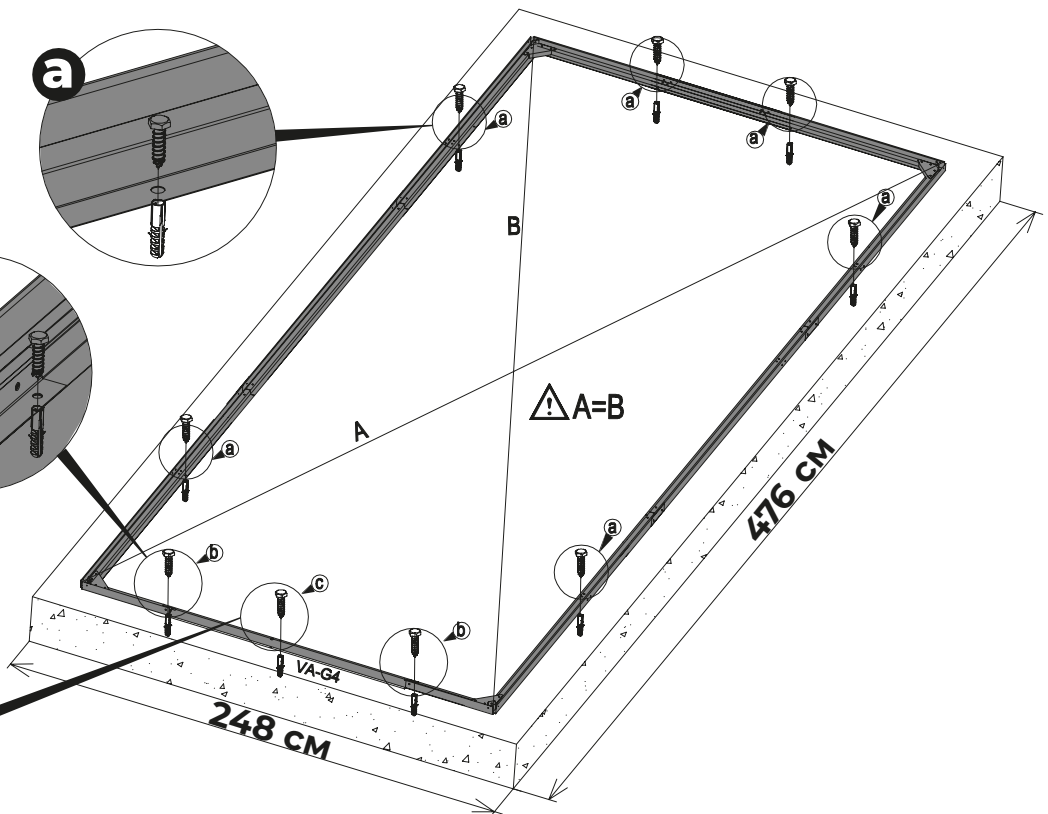
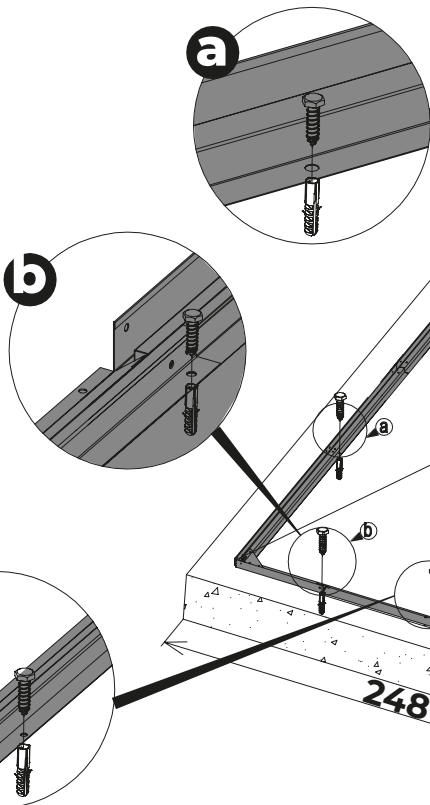

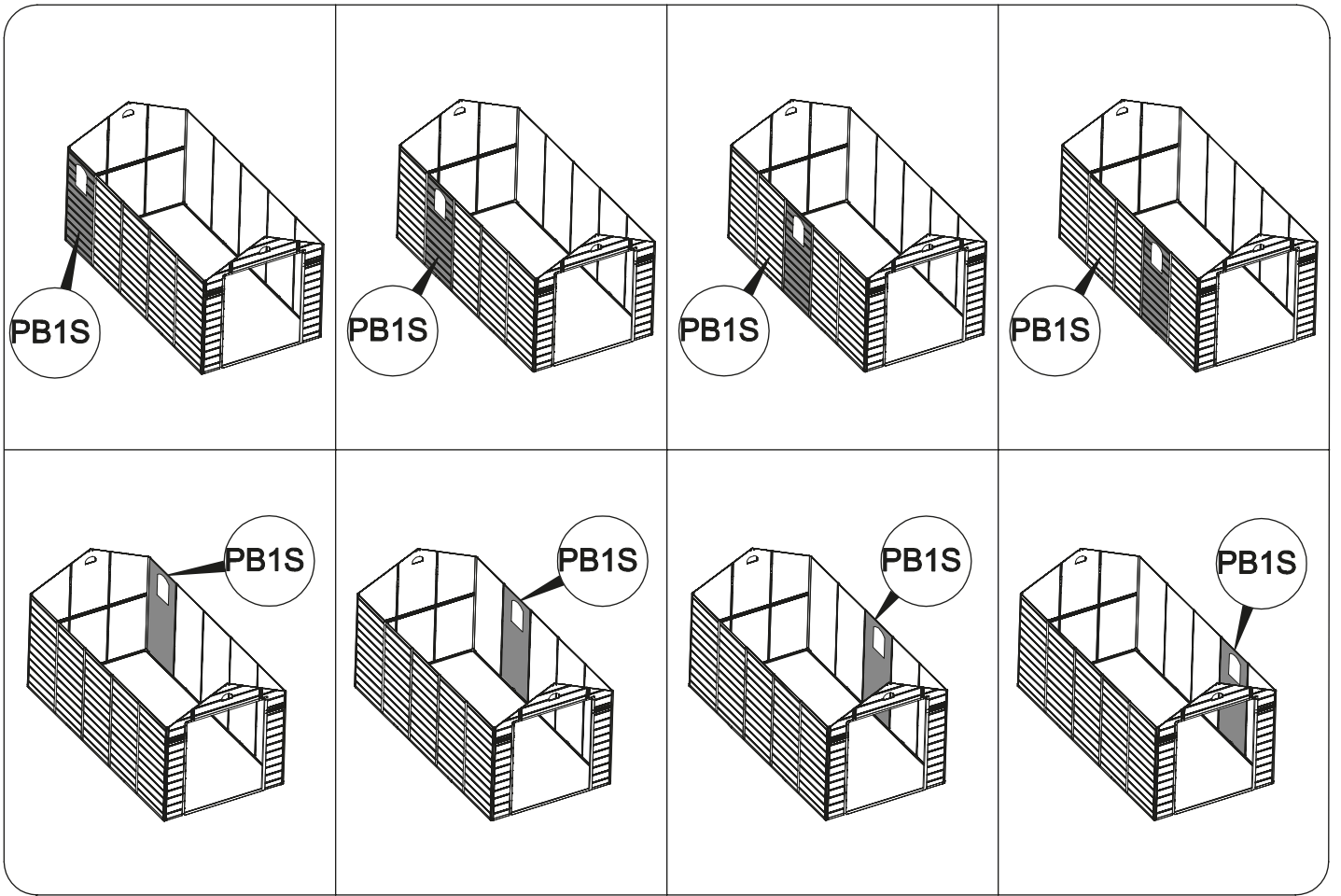

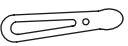

VA-J48 [x9]
40 MM



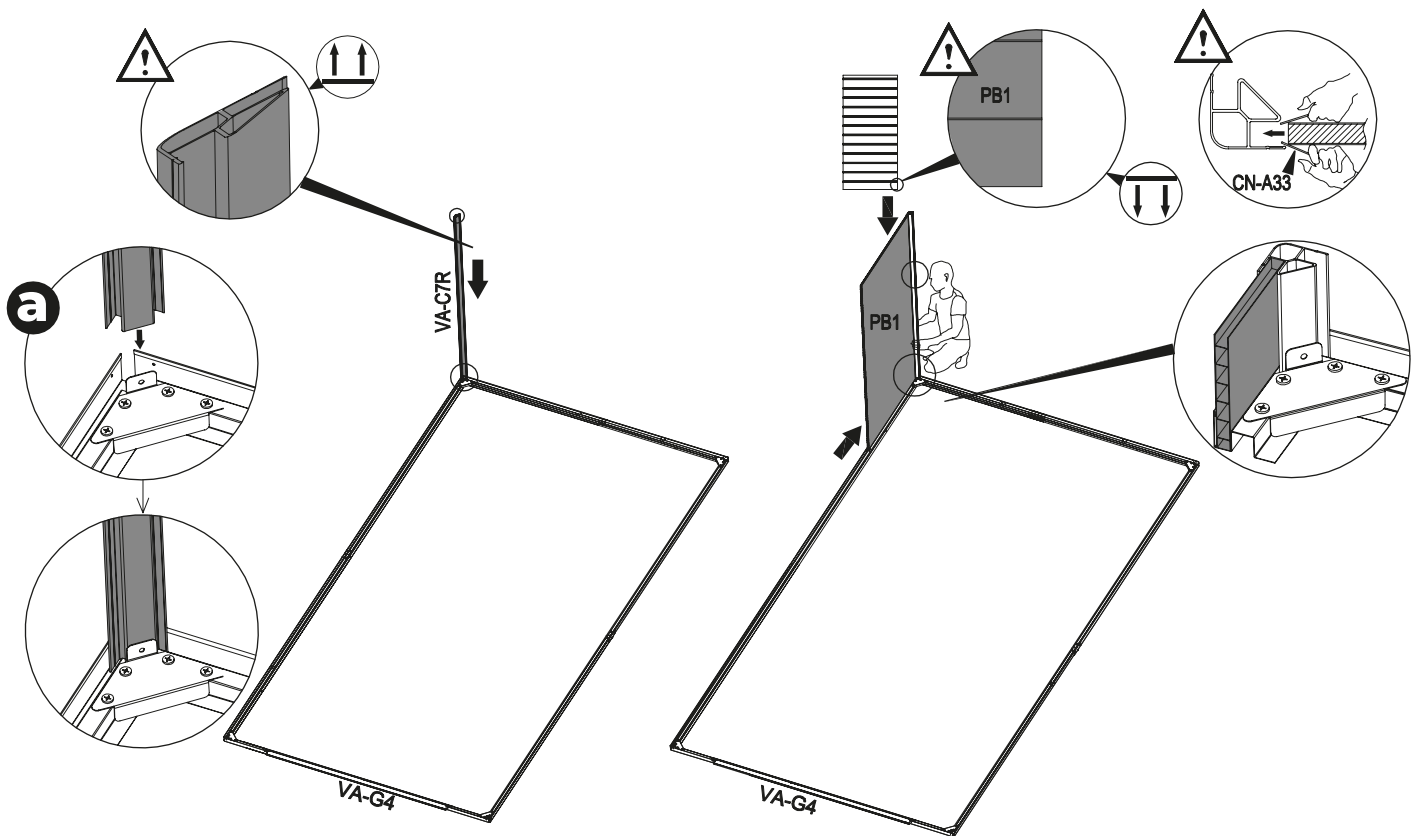





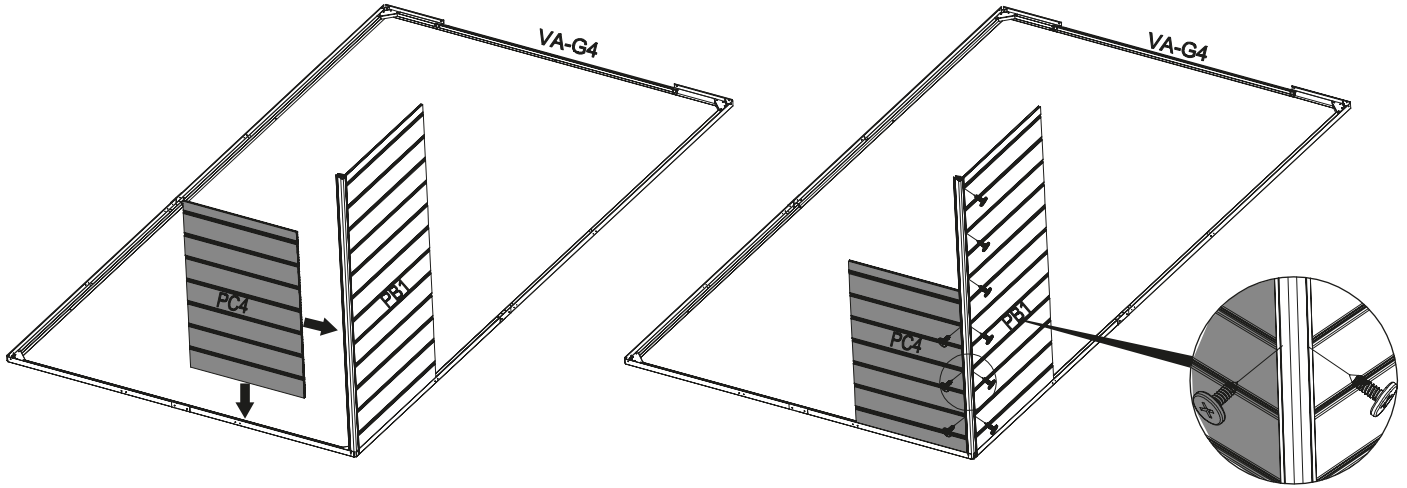
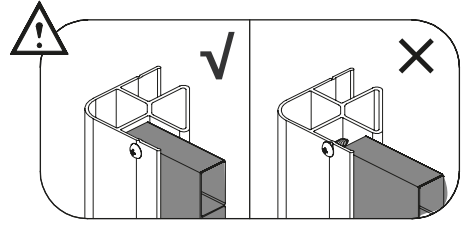
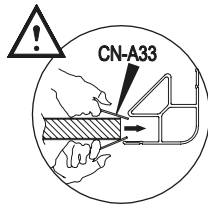
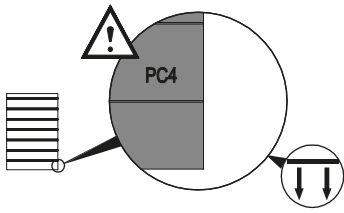

5	 PB1 [x1] 876x1840 mm	 VA-C7R [x1] 1860 mm	 CN-A33	
----------	----------------------------------------------------------------------------------------------------------------	---------------------------------------------------------------------------------------------------------------	-----------------------------------------------------------------------------------------------	---------------------------------------------------------------------------------------



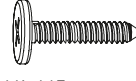

6	PC4 [x1] 743x1100 mm		VA-J45 [x9] 19 mm		CN-A33		
----------	-------------------------	----------------------------------------------------------------------------------	----------------------	----------------------------------------------------------------------------------	--------	-----------------------------------------------------------------------------------	------------------------------------------------------------------------------------



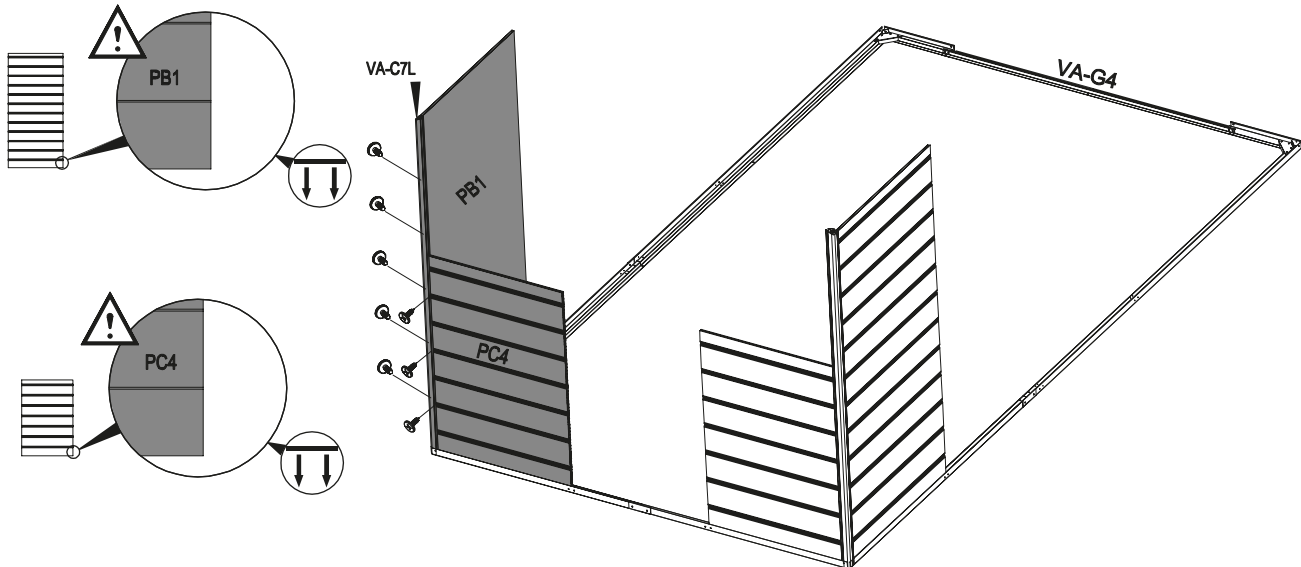
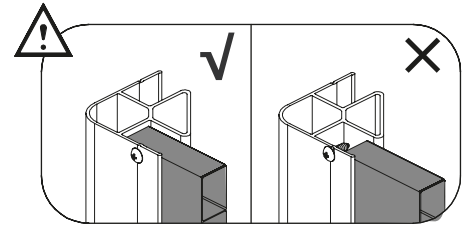
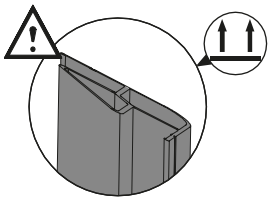



7	VA-C7L [x1] 1860 mm		PB1 [x1] 876x1840 mm		PC4 [x1] 743x1100 mm		VA-J45 [x9] 19 mm		CN-A33	
----------	------------------------	-------------------------------------------------------------------------------------	-------------------------	-------------------------------------------------------------------------------------	-------------------------	--------------------------------------------------------------------------------------	----------------------	---------------------------------------------------------------------------------------	--------	---------------------------------------------------------------------------------------

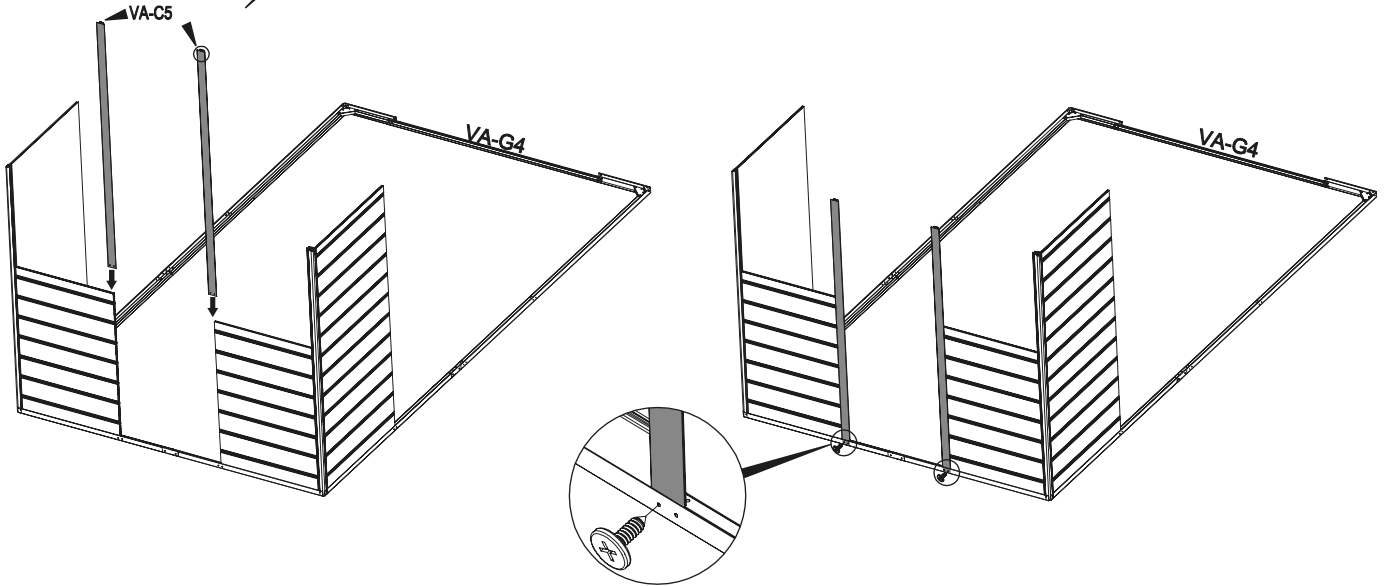
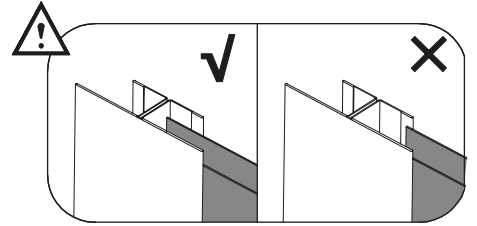
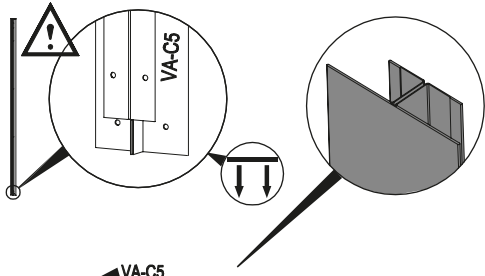

8	 VA-C5 [x2] 1840 MM	 VA-J44 [x2] 13 MM	 CN-A33	
----------	-----------------------------------------------------------------------------------------------------------	-----------------------------------------------------------------------------------------------------------	---------------------------------------------------------------------------------------------	--

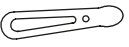

9	 PC4 [x1] 743x1110 MM	 VA-J44 [x4] 13 MM	 CN-A33	
----------	----------------------------------------------------------------------------------------------------------------	-------------------------------------------------------------------------------------------------------------	-----------------------------------------------------------------------------------------------	---------------------------------------------------------------------------------------

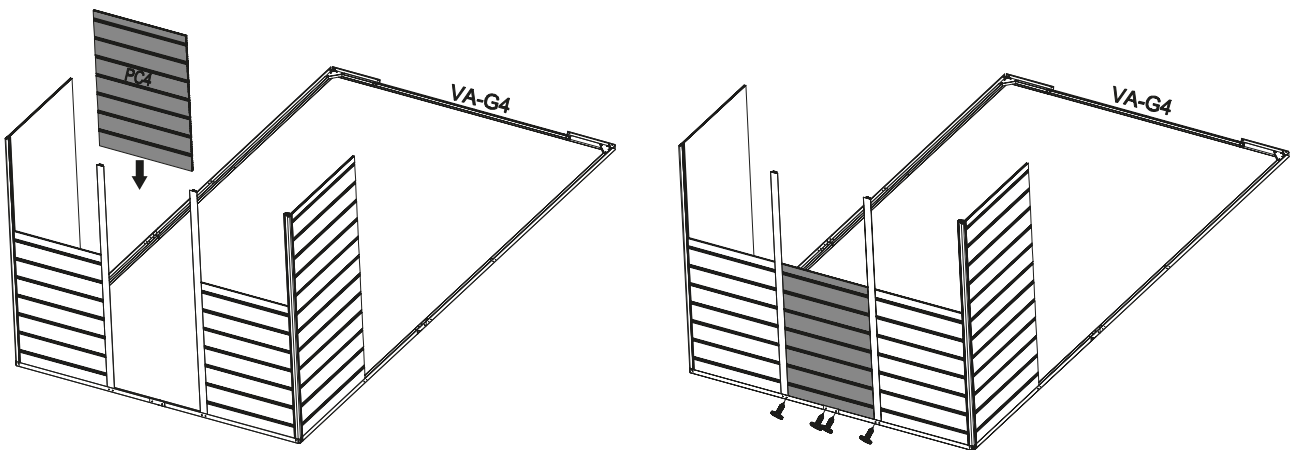
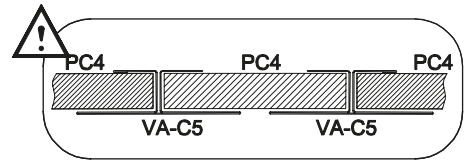
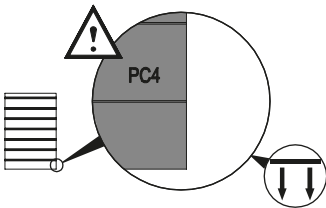



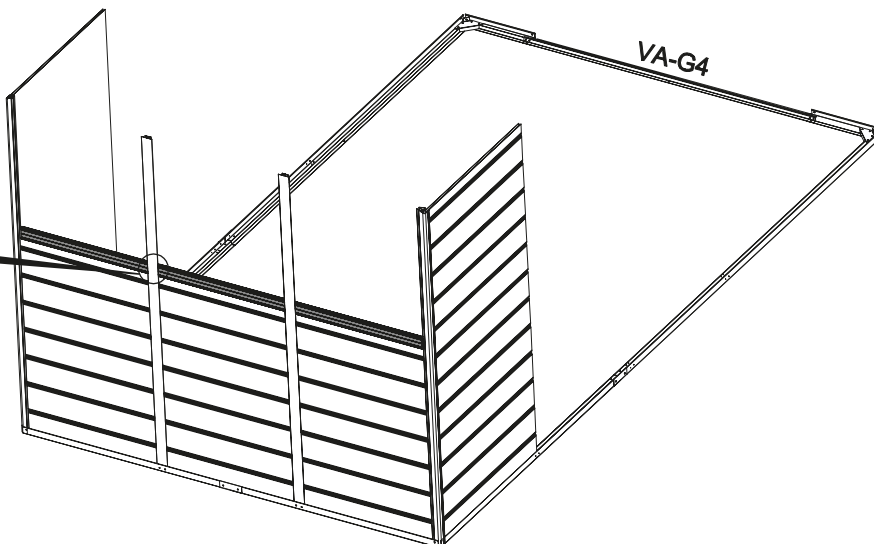
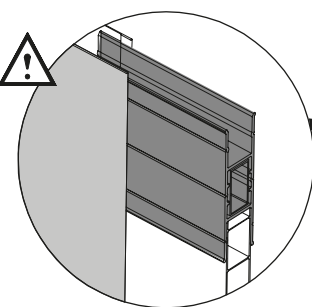
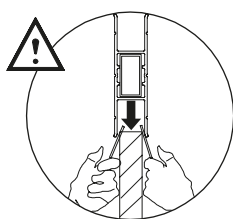
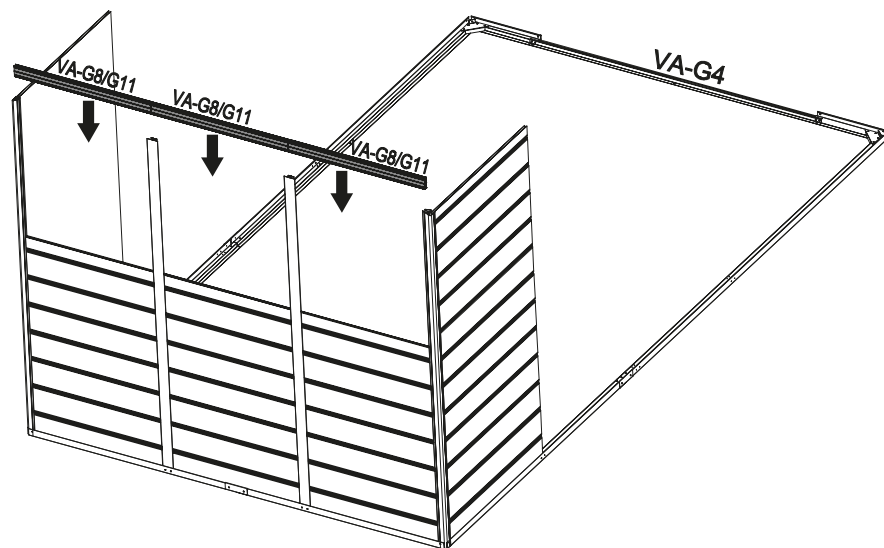
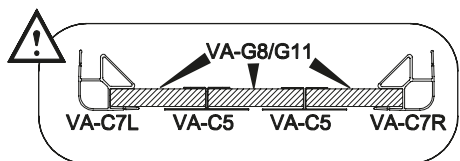
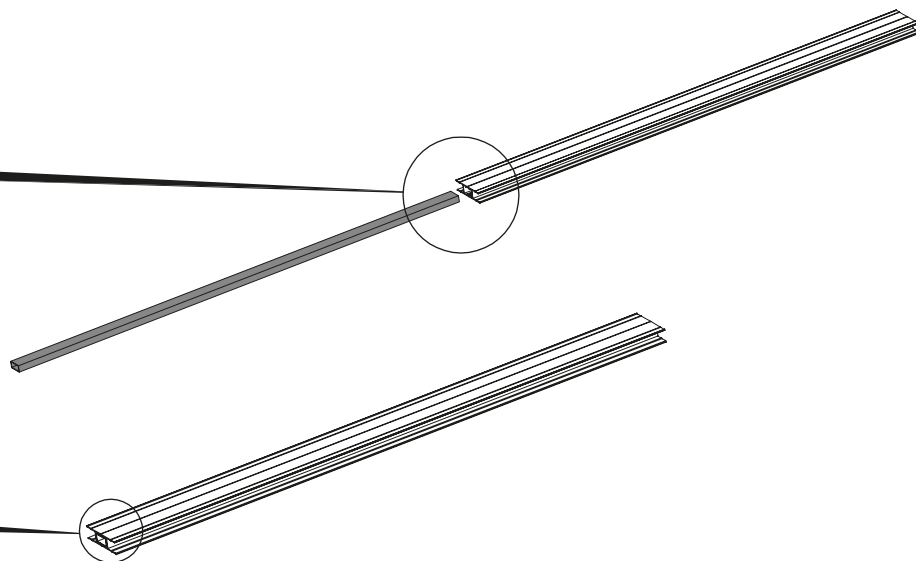
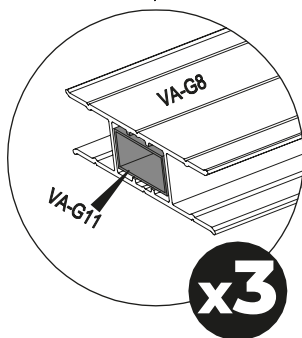
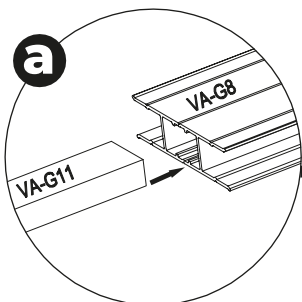
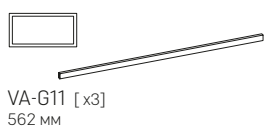
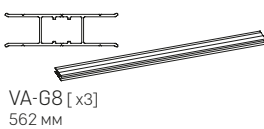

10

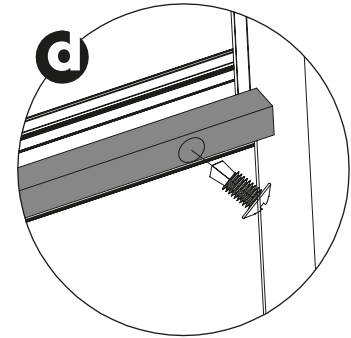
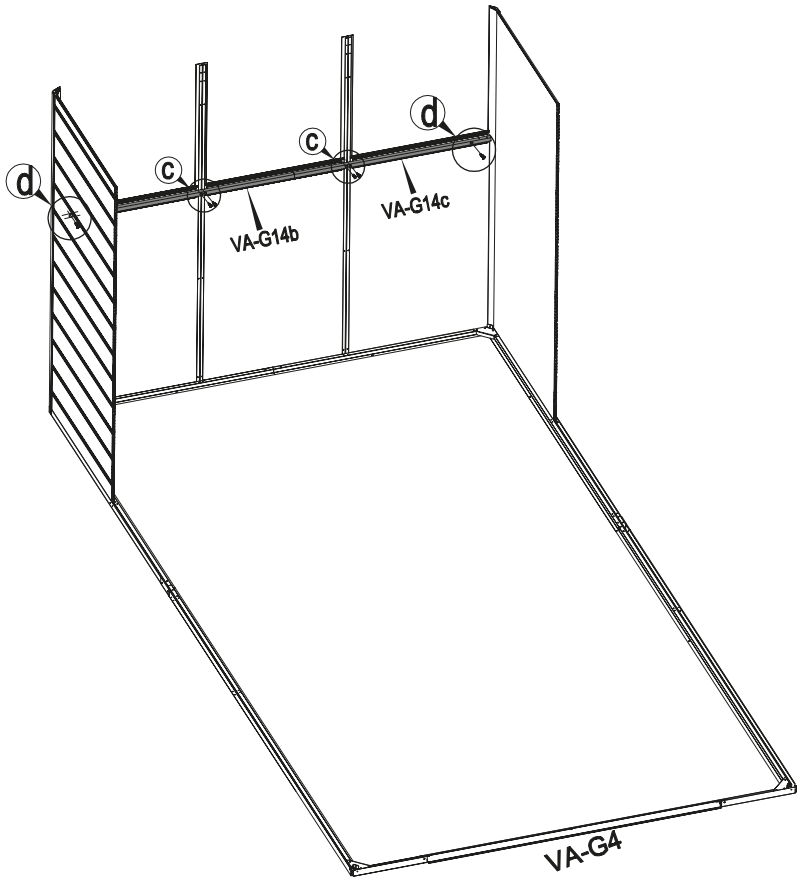
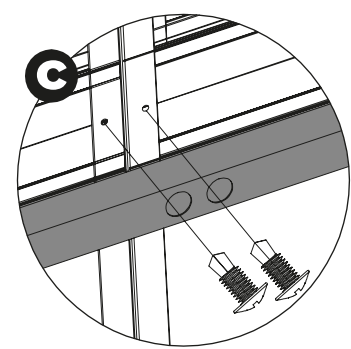
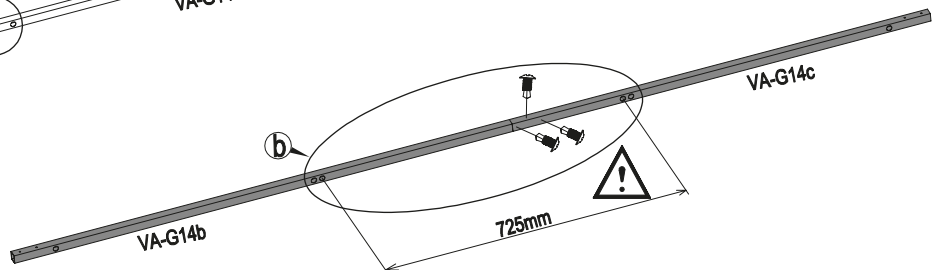
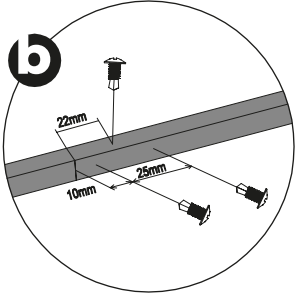
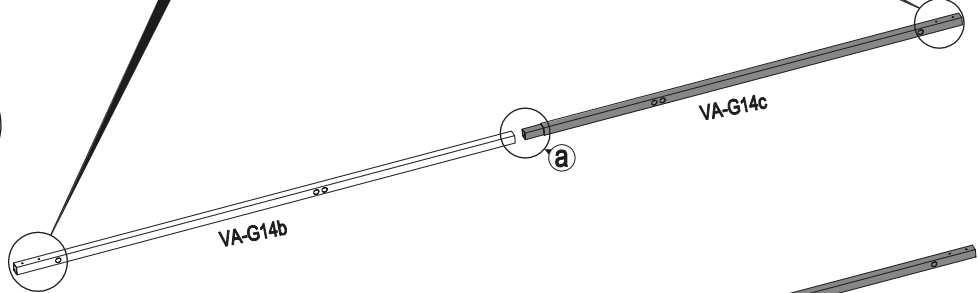
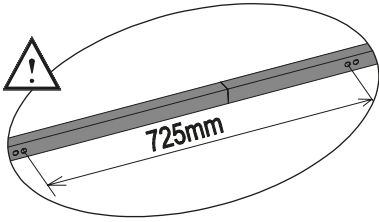
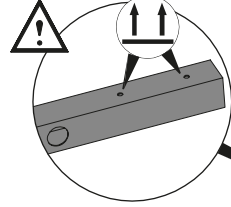
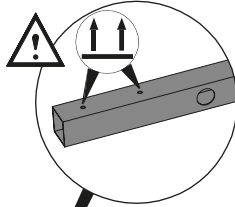
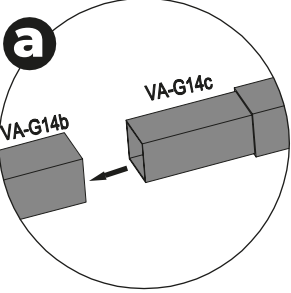
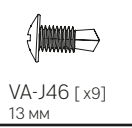
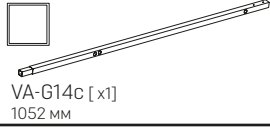
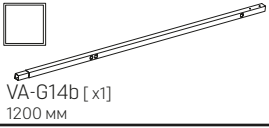



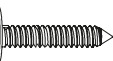

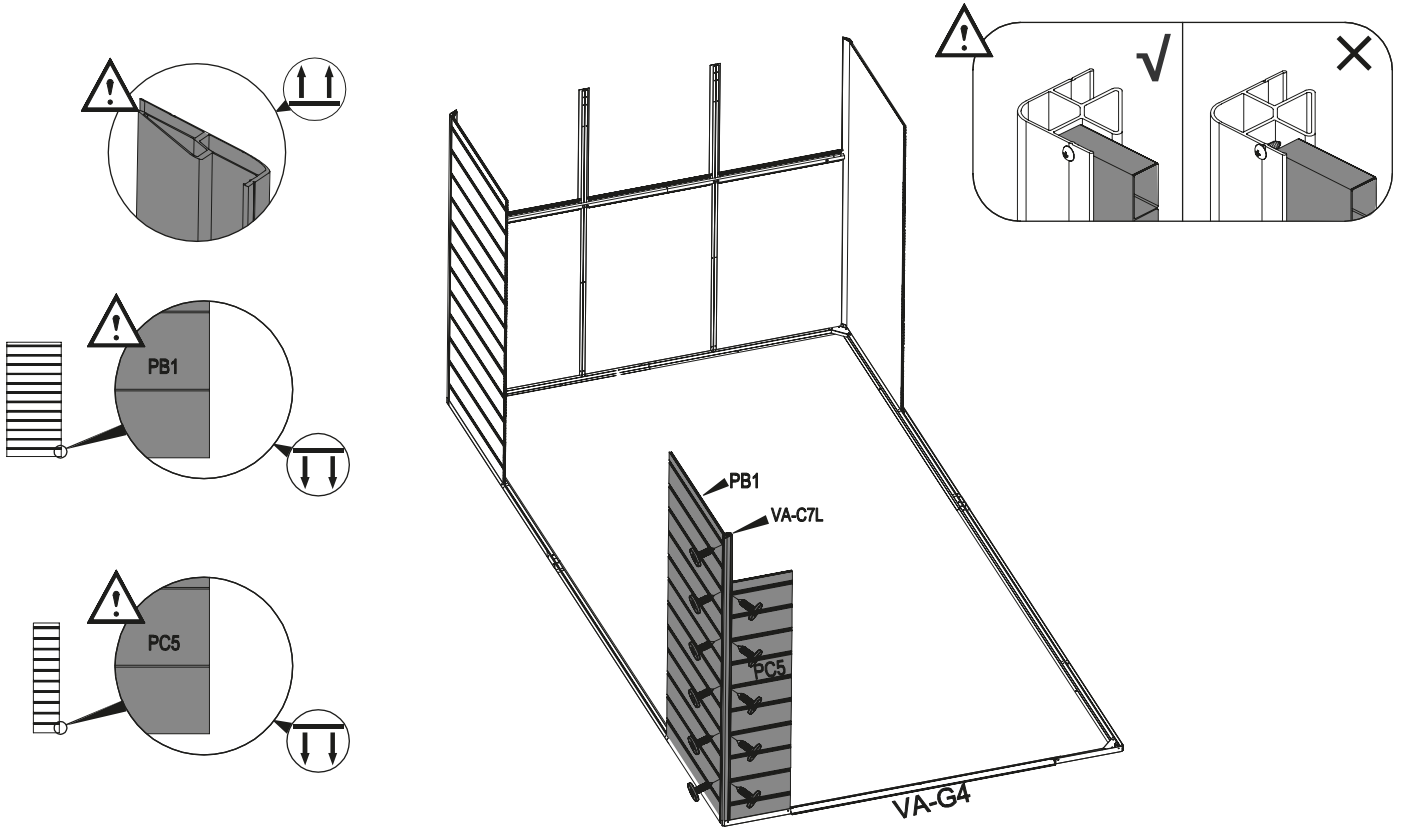

11



12	 VA-C7L [x1] 1860 MM	 PB1 [x1] 876x1840 MM	 PC5 [x1] 365x1548 MM	 VA-J45 [x11] 19 MM	 CN-A33	
----	------------------------------------------------------------------------------------------------------------	-------------------------------------------------------------------------------------------------------------	-------------------------------------------------------------------------------------------------------------	-------------------------------------------------------------------------------------------------------------	----------------------------------------------------------------------------------------------	-------------------------------------------------------------------------------------



13	 VA-C7R [x1] 1860 MM	 PB1 [x1] 876x1840 MM	 PC5 [x1] 365x1548 MM	 VA-J45 [x11] 19 MM	 CN-A33	
----	---------------------------------------------------------------------------------------------------------------	----------------------------------------------------------------------------------------------------------------	----------------------------------------------------------------------------------------------------------------	----------------------------------------------------------------------------------------------------------------	-------------------------------------------------------------------------------------------------	---------------------------------------------------------------------------------------

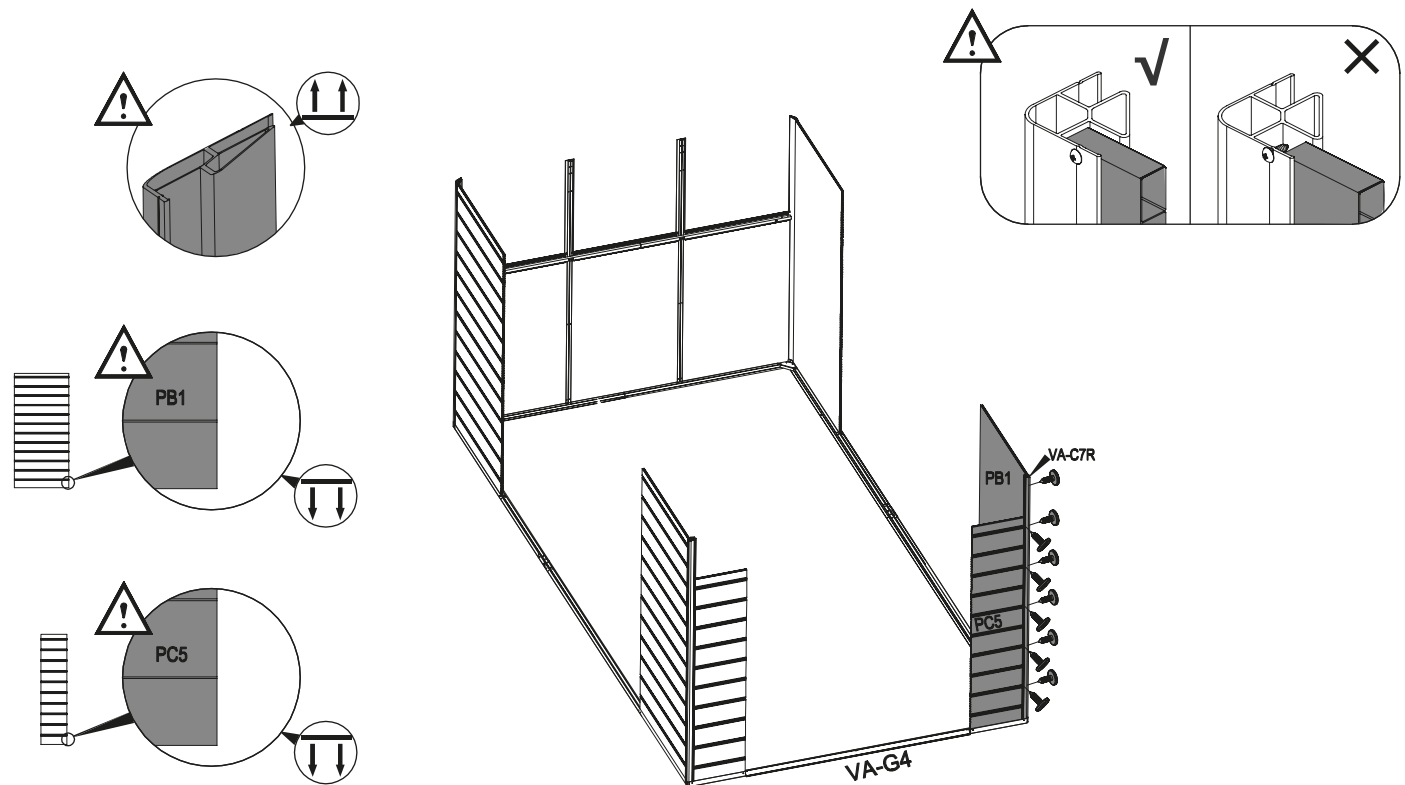

14

VA-31 [x4]



VA-J44 [x8]
13 mm

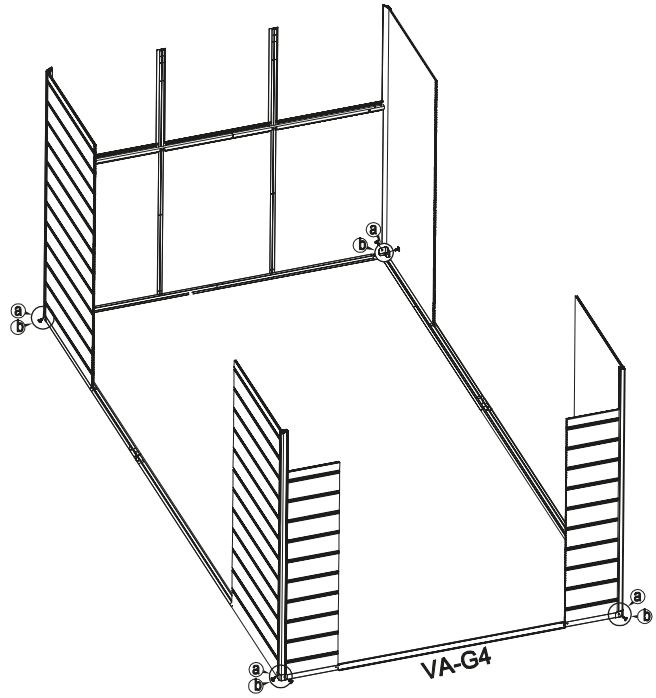
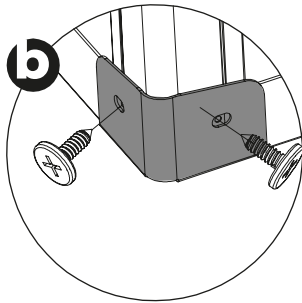
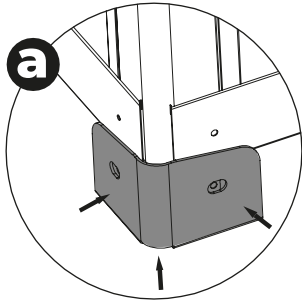

15

VA-J44 [x4]
13 mm

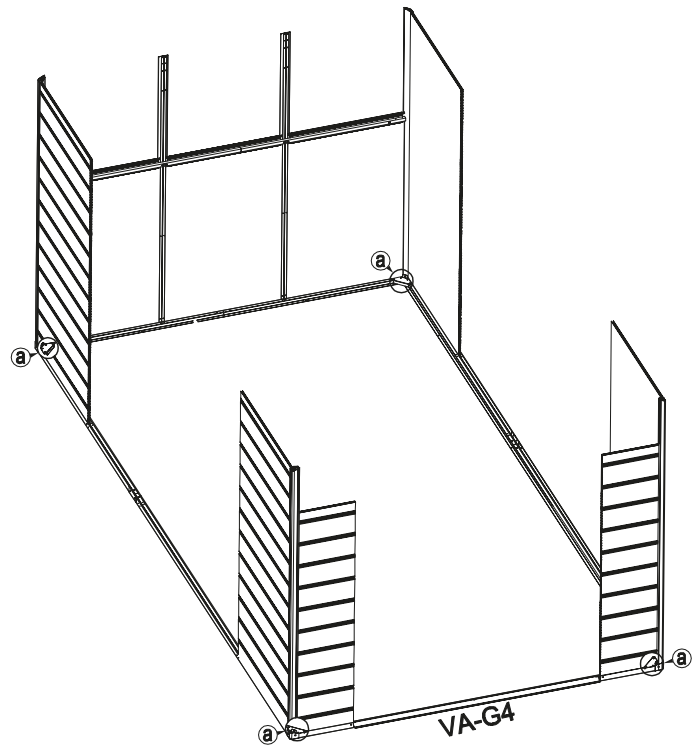
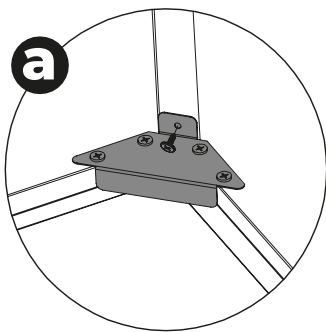

16

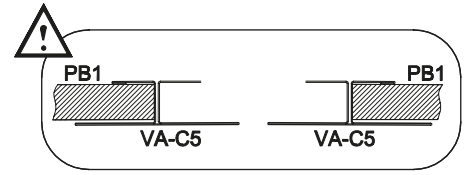
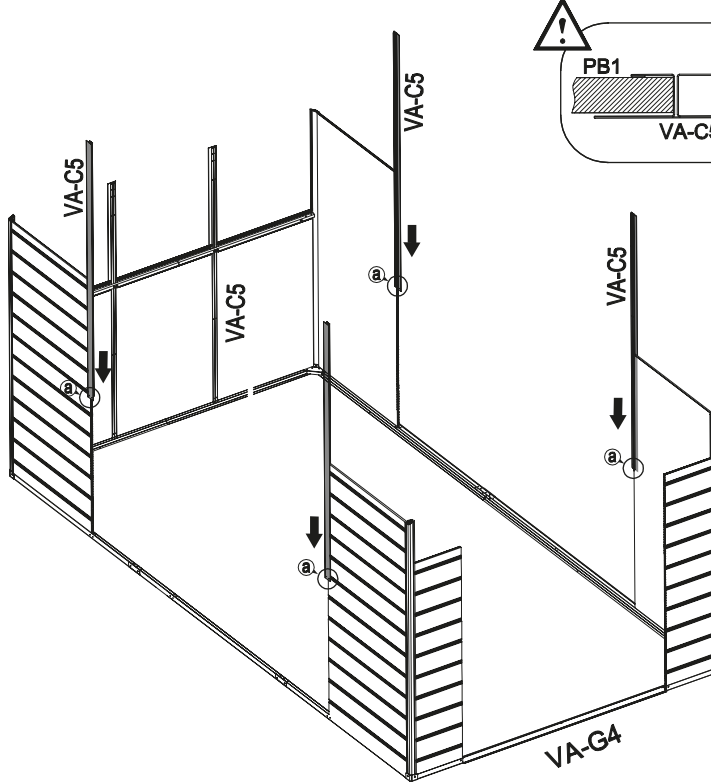
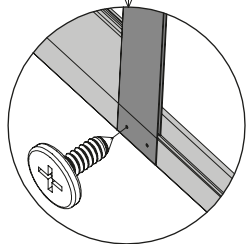
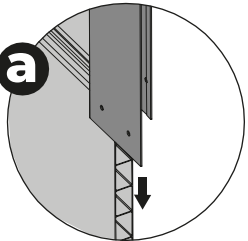
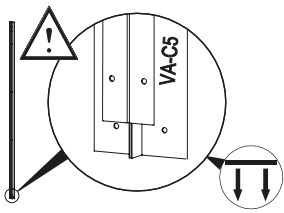
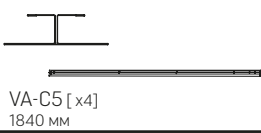

17

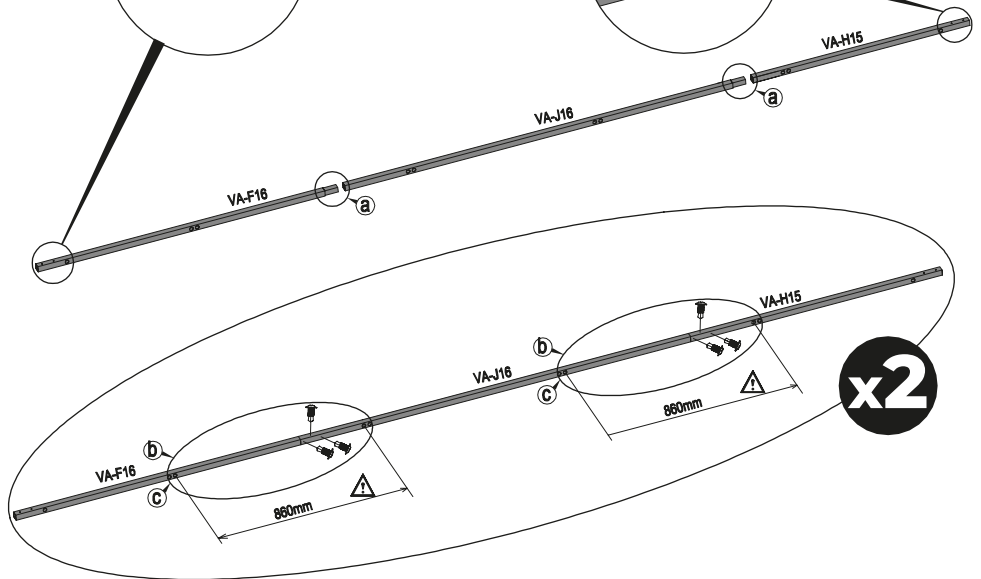
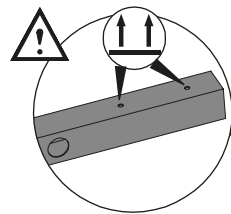
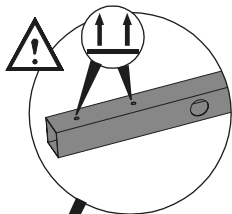
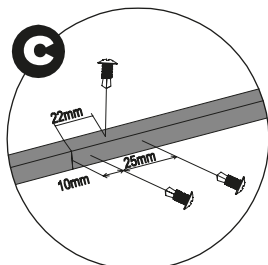
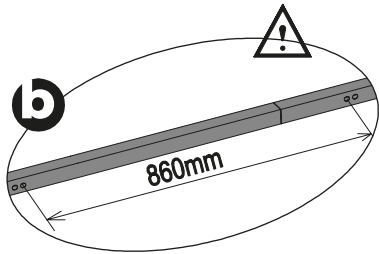
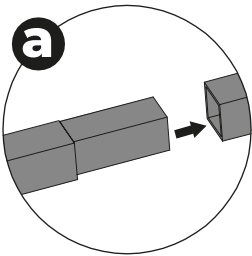
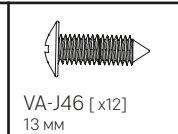
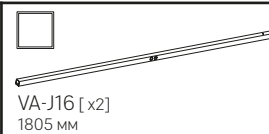
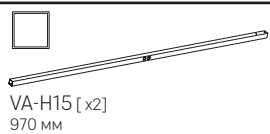
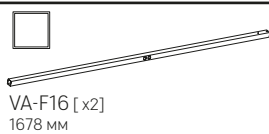

x2

18

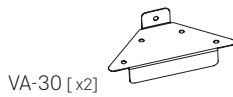

VA-30 [x2]



VA-J44 [x10]
13 MM



VA-J49 [x4]
13 MM

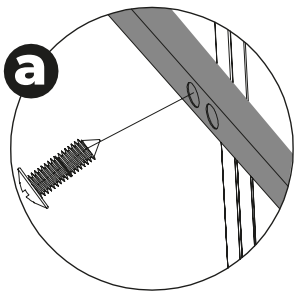

a

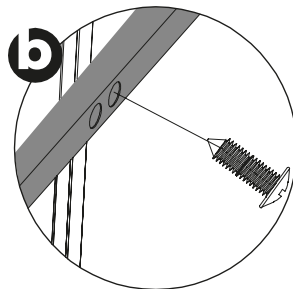
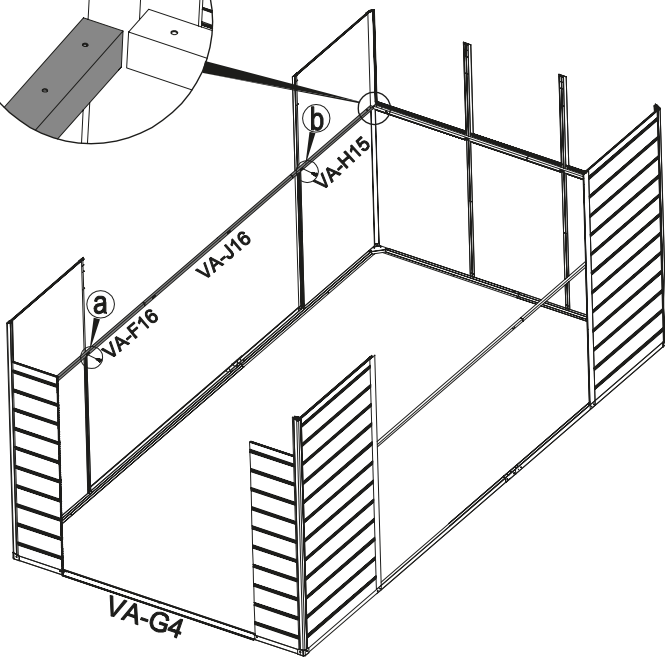
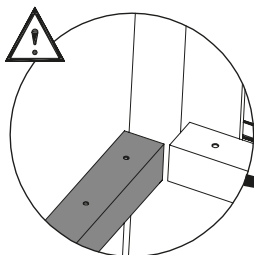
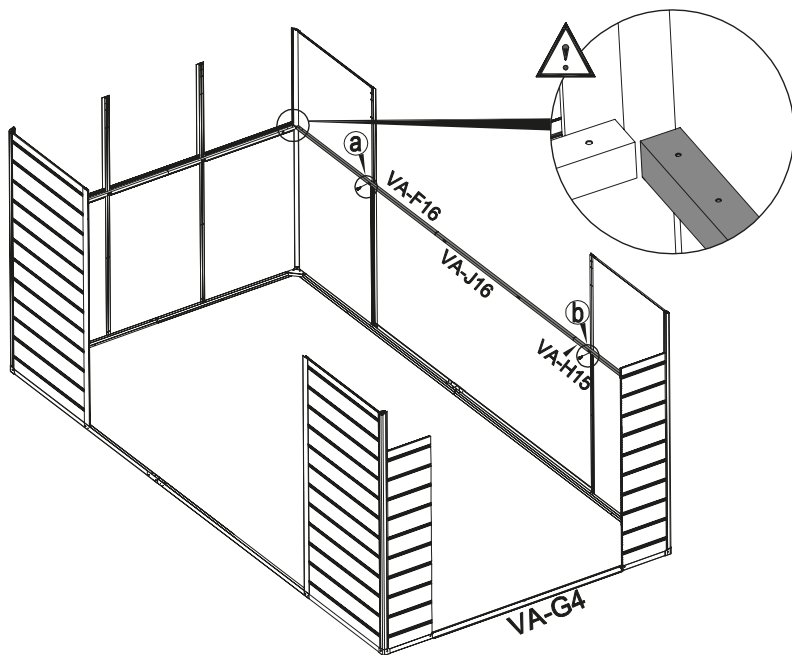

b

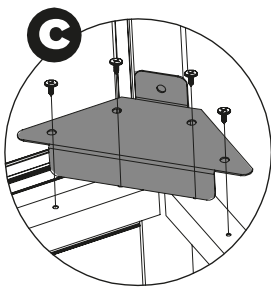

c

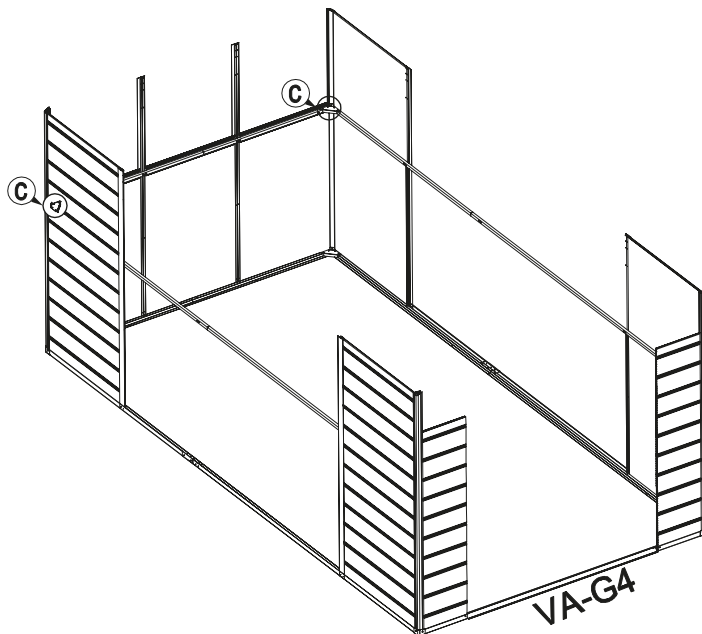
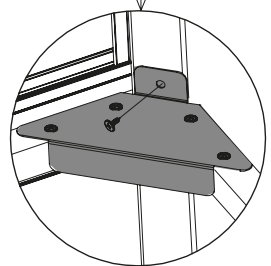

19

PB1 [x2]
876x1840 mm



VA-C5 [x2]
1840 mm



CN-A33

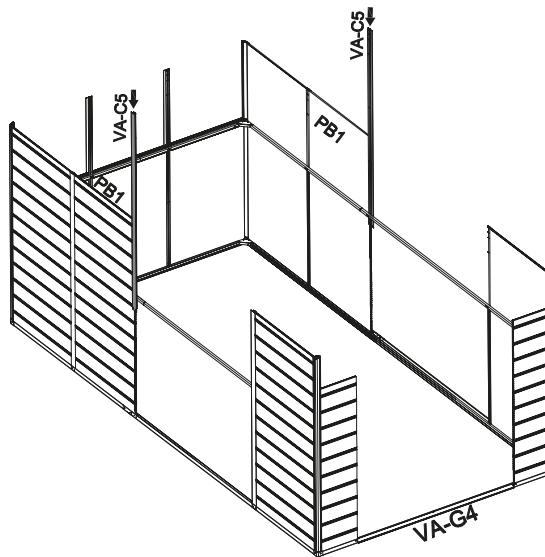
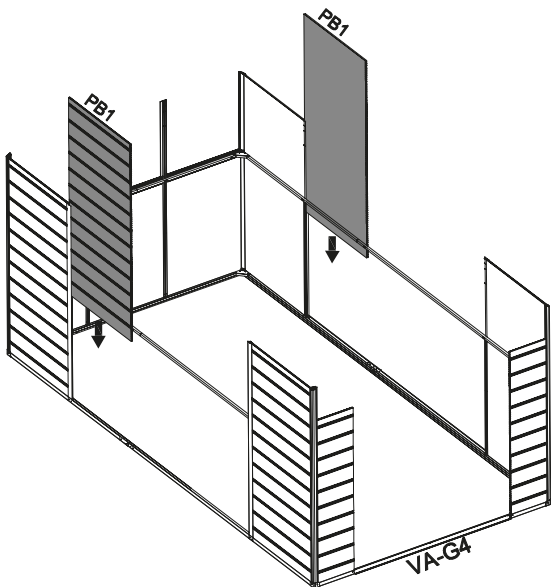
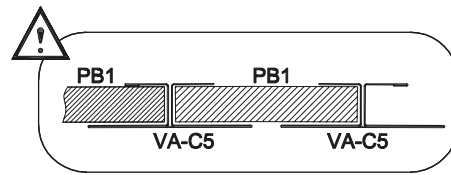
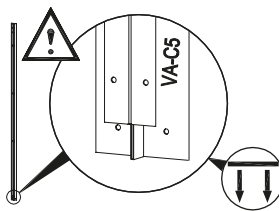
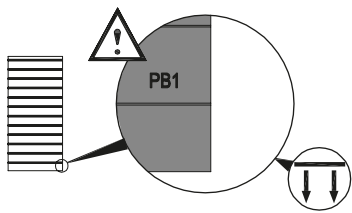

20

PB1 [x2]
876x1840 mm





VA-C5 [x2]
1840 mm

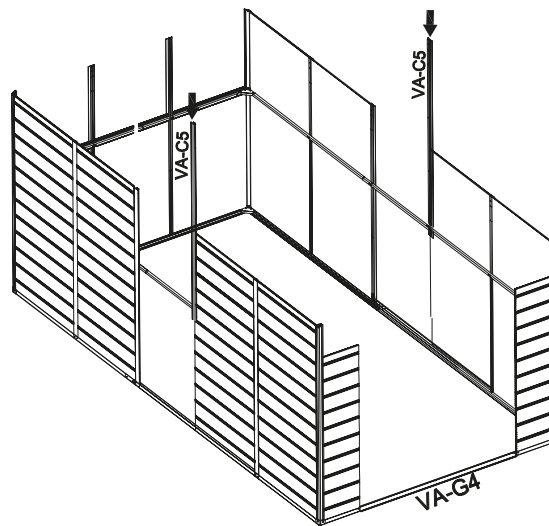
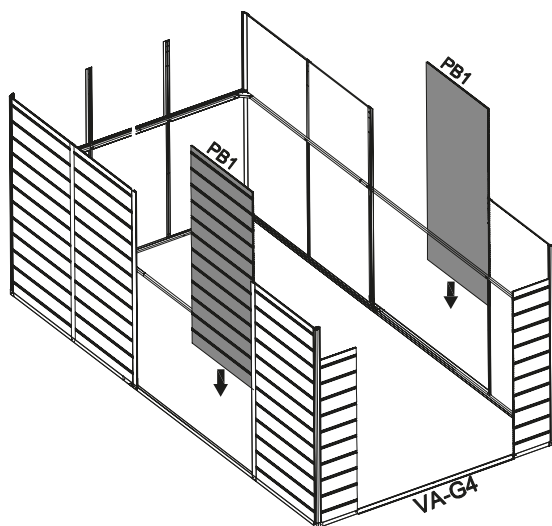
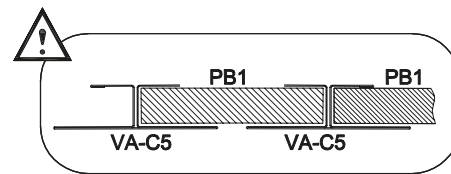
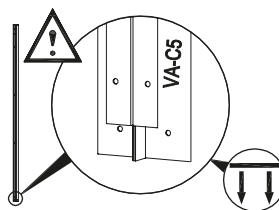
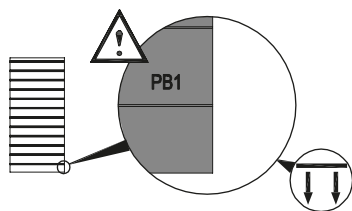

CN-A33

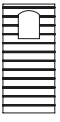

21	 PB1 [x1] 876x1840 mm	 PB1S [x1] 876x1840 mm	 CN-A33	
-----------	-------------------------------------------------------------------------------------------------------------	--------------------------------------------------------------------------------------------------------------	---------------------------------------------------------------------------------------------	------------------------------------------------------------------------------------

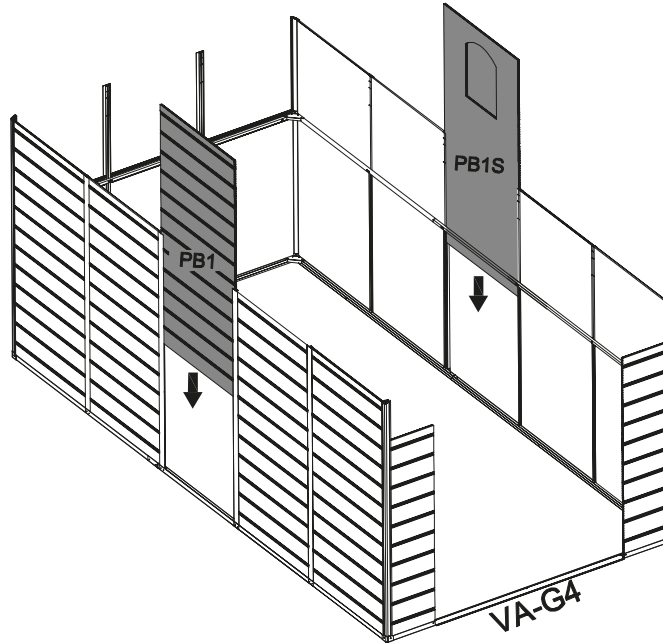
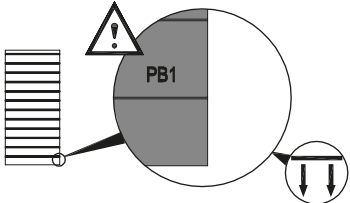
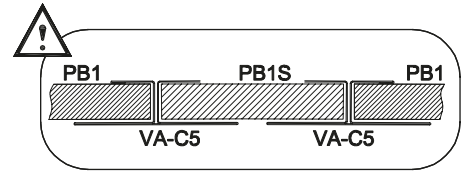
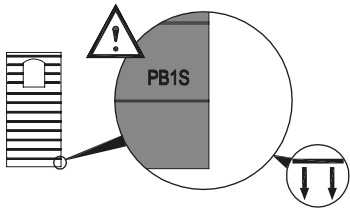

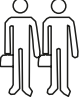
22	 VA-J44 [x20] 13 mm	
-----------	--------------------------------------------------------------------------------------------------------------	---------------------------------------------------------------------------------------

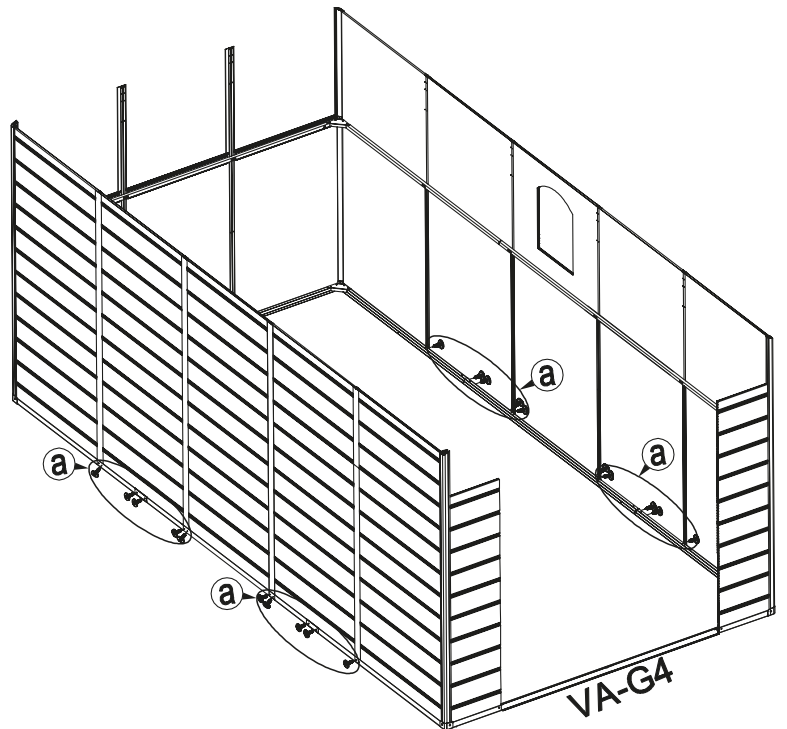
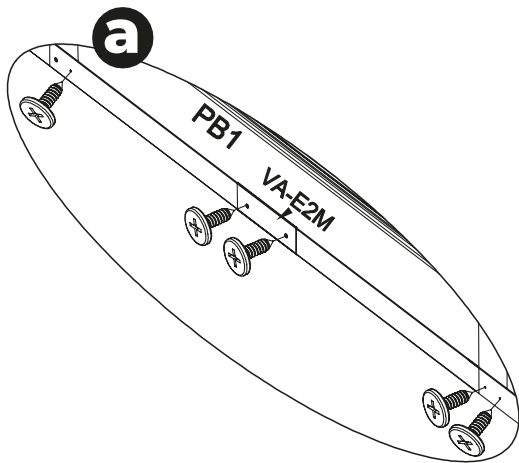

23



VA-J49 [x12]
13 MM

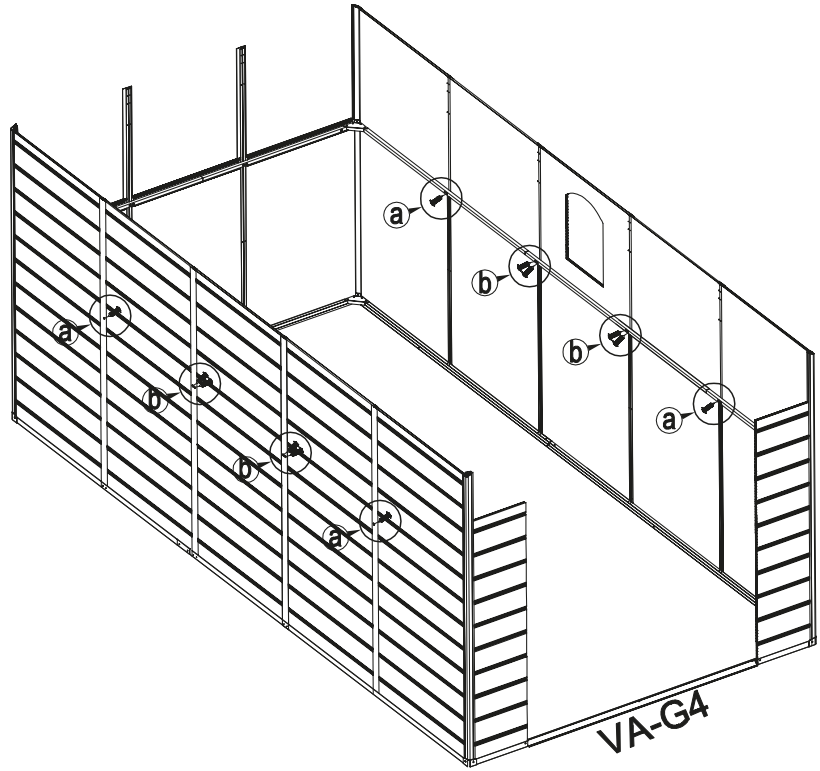
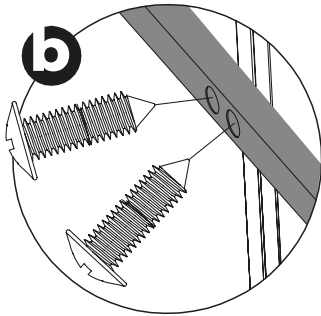
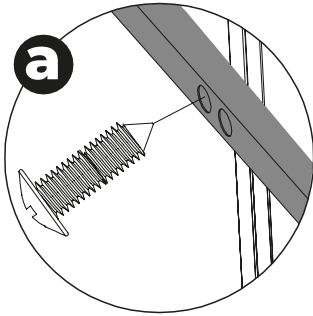

VA-G4

24

PC3L [x1]
743x1072 MM



PC3R [x1]
743x1072 MM



PC3S [x1]
743x1248 MM

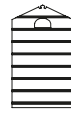

VA-J45 [x6]
19 MM

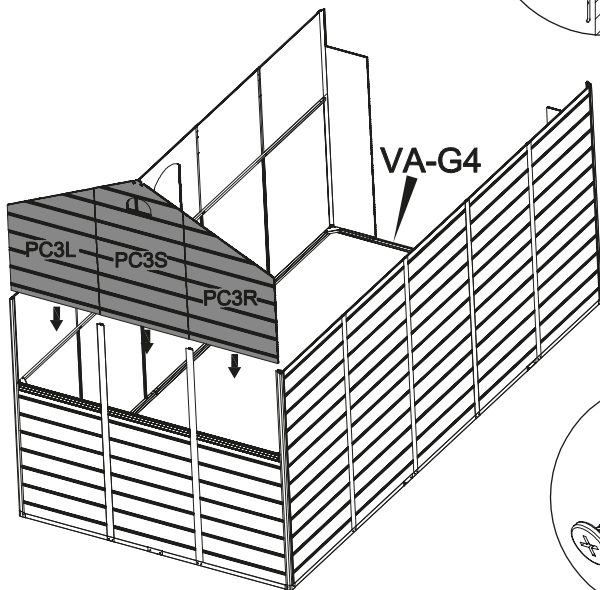
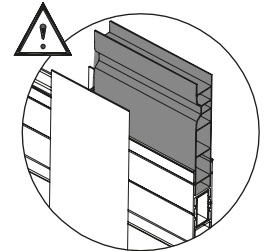
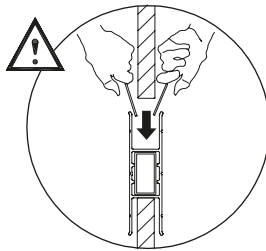
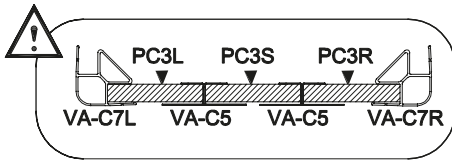
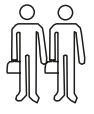

VA-G4

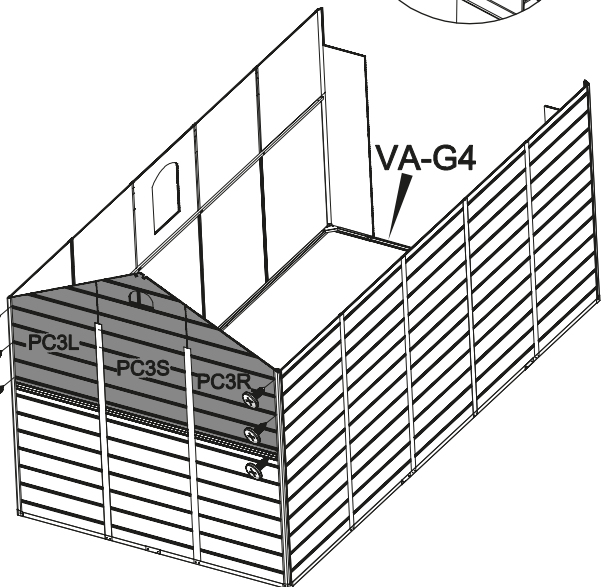

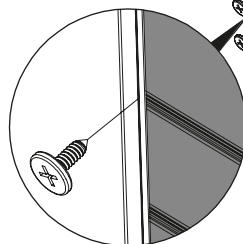

VA-G4

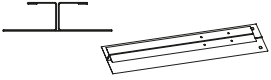
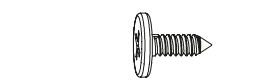
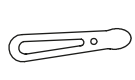

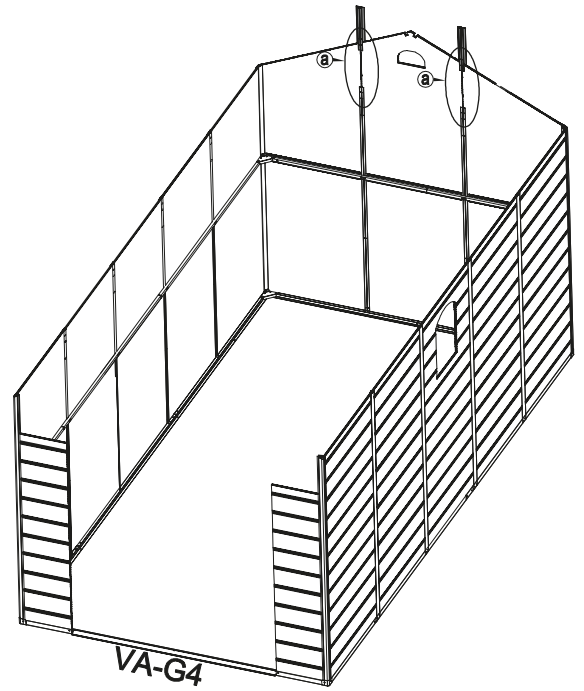
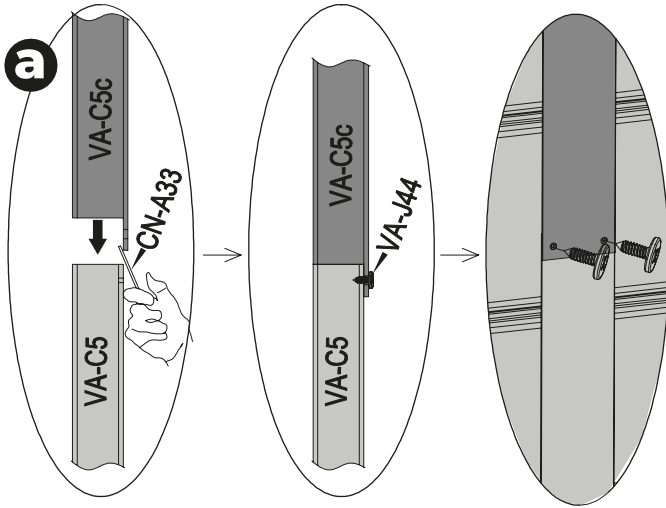
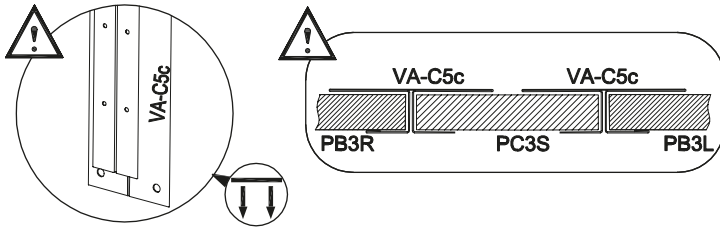

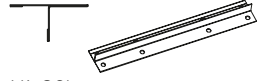

<p>25</p>	 <p>VA-C5c [x2] 365 MM</p>	 <p>VA-J44 [x4] 13 MM</p>	 <p>CN-A33</p>
------------------	----------------------------------------------------------------------------------------------------------------	---------------------------------------------------------------------------------------------------------------	------------------------------------------------------------------------------------------------

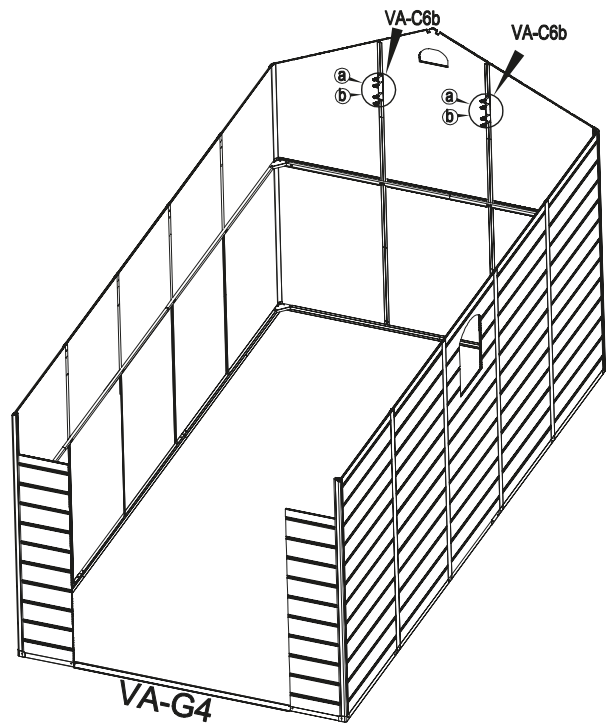
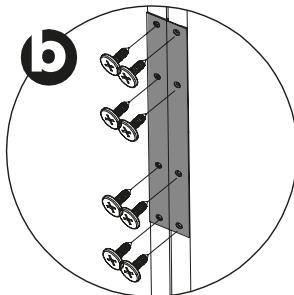
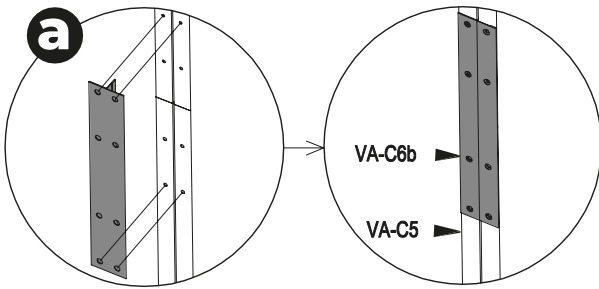

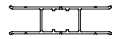



<p>26</p>	 <p>VA-C6b [x2] 200 MM</p>	 <p>VA-J44 [x16] 13 MM</p>	
------------------	-------------------------------------------------------------------------------------------------------------------	-------------------------------------------------------------------------------------------------------------------	--

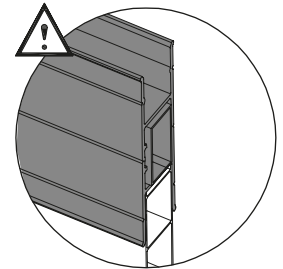
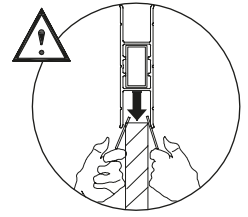
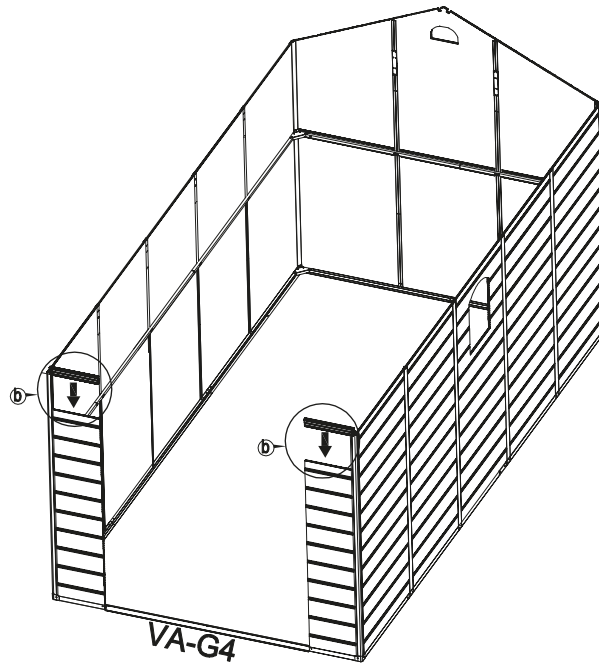
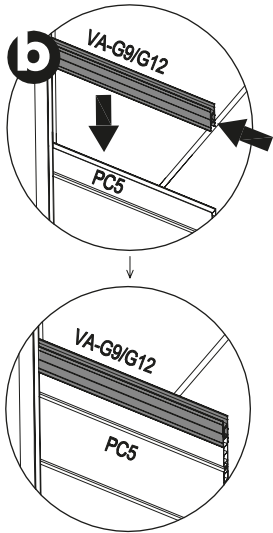
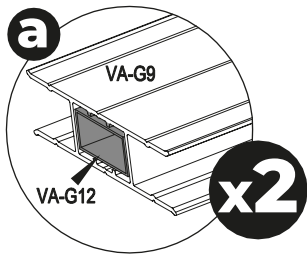

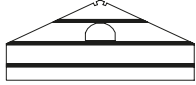
27	 VA-G9 [x2] 360 MM	 VA-G12 [x2] 360MM		 CN-A33	
-----------	----------------------------------------------------------------------------------------------------------	----------------------------------------------------------------------------------------------------------	--	-----------------------------------------------------------------------------------------------	------------------------------------------------------------------------------------

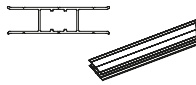
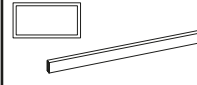

28	 PC2S [x1] 1270x542 MM	 PC2L [x1] 461x492 MM	 PC2R [x1] 461x492MM	 VA-G9b [x2] 254 MM	 VA-G12b [x2] 225 MM	 VA-J44 [x8] 13 MM
-----------	-----------------------------------------------------------------------------------------------------------------	----------------------------------------------------------------------------------------------------------------	---------------------------------------------------------------------------------------------------------------	---------------------------------------------------------------------------------------------------------------	-----------------------------------------------------------------------------------------------------------------	---------------------------------------------------------------------------------------------------------------

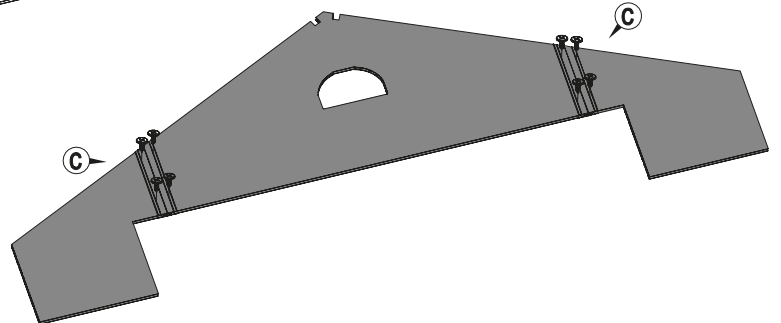
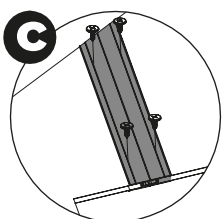
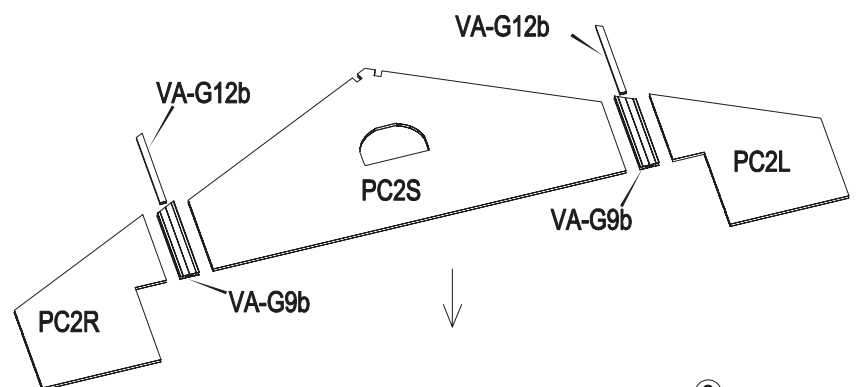
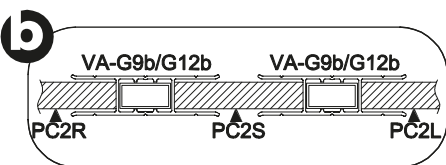
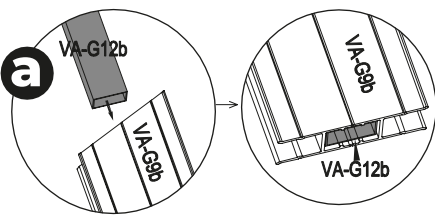

29

VA-J45 [x2]
19 MM

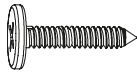

CN-A33

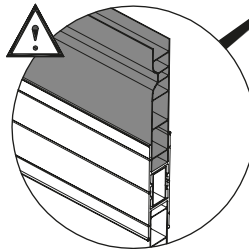
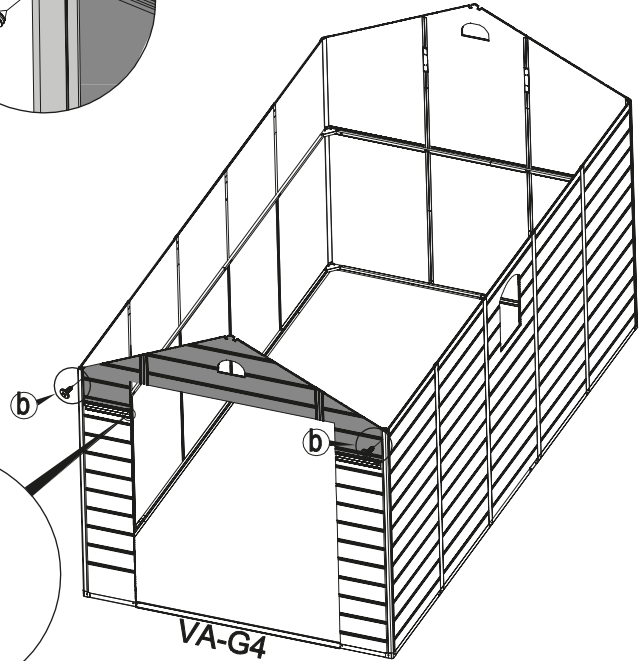
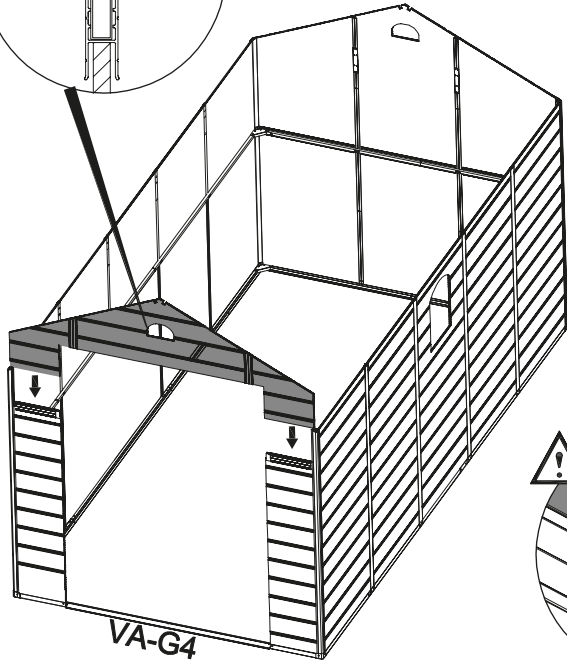
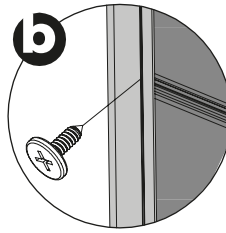
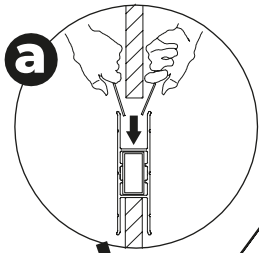
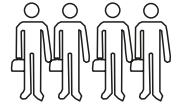

30

VA-C25L [x1]
1830 MM



VA-C25R [x1]
1830 MM





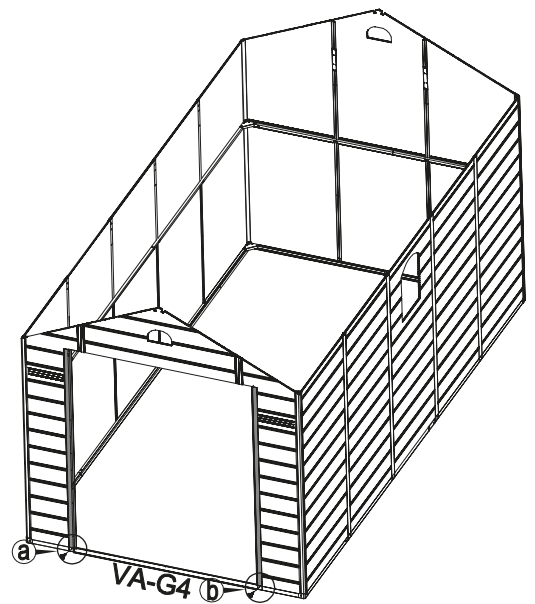
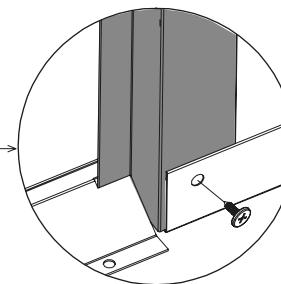
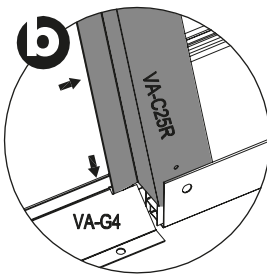
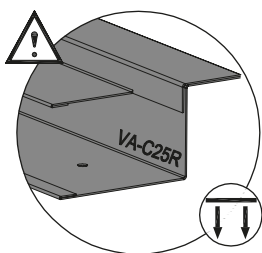
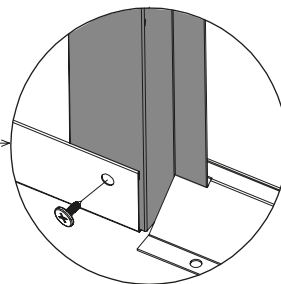
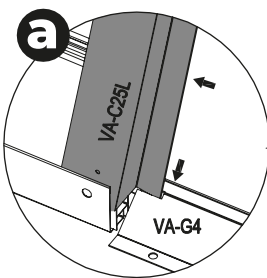
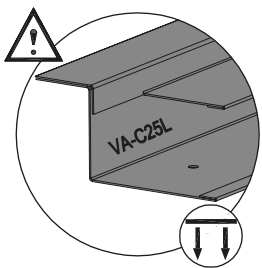

VA-J44 [x2]
13 MM

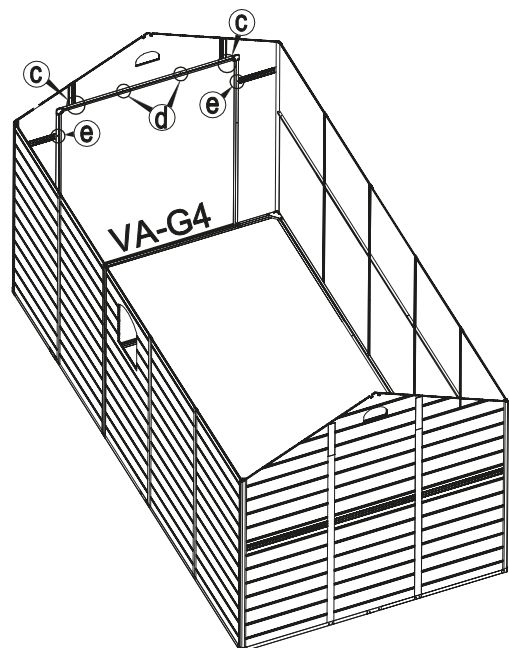
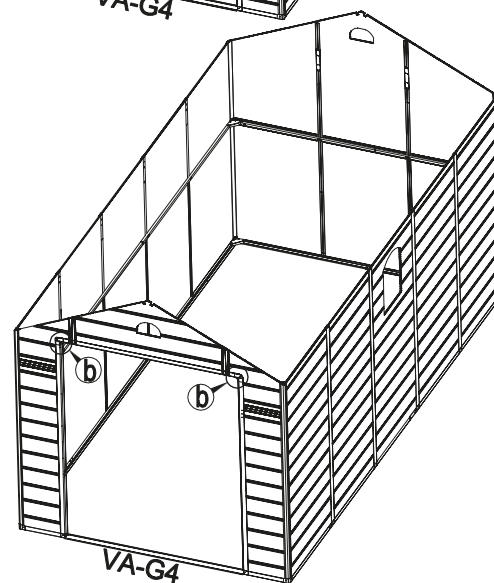
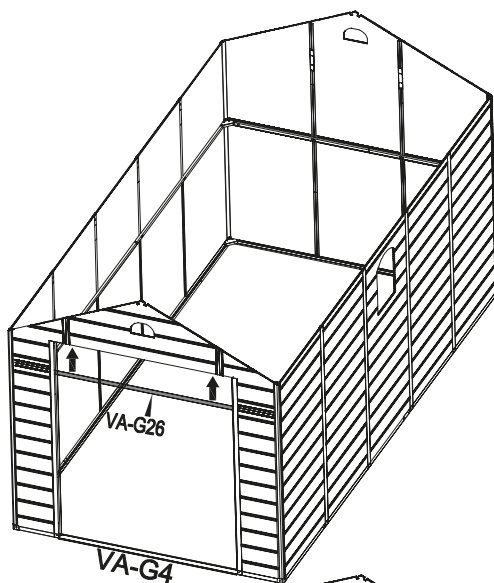
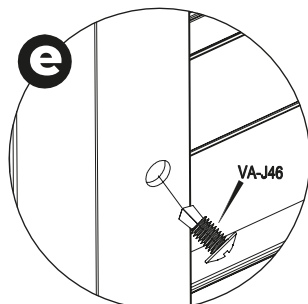
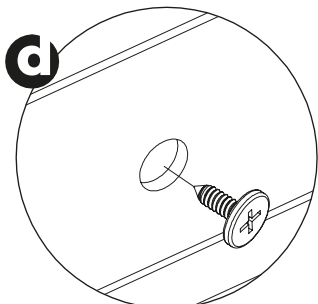
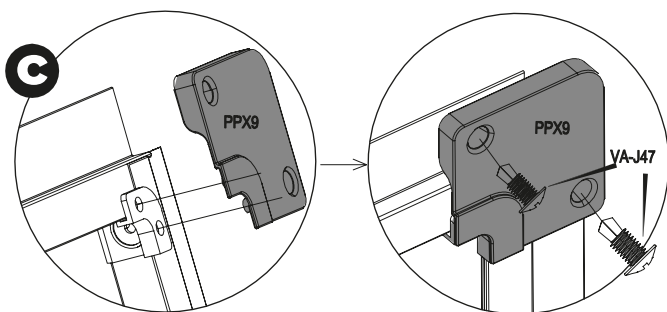
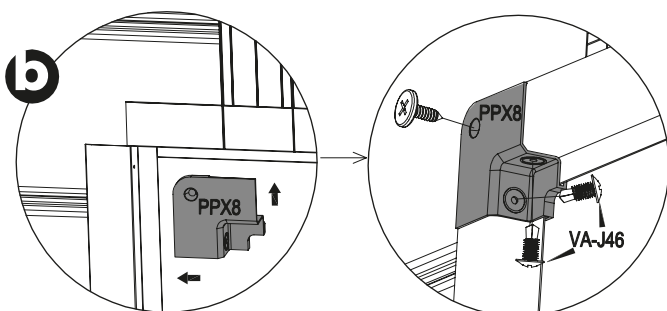
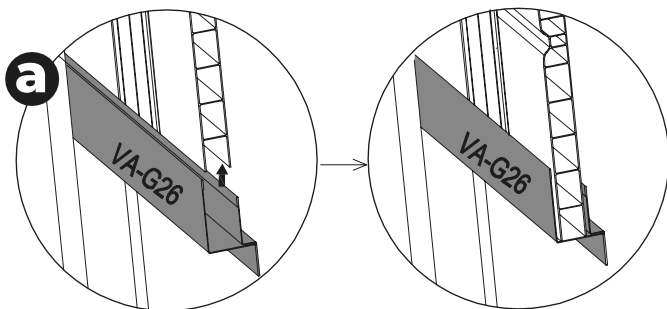
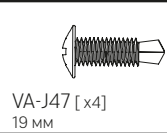
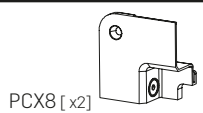

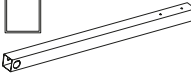
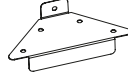

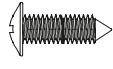

31

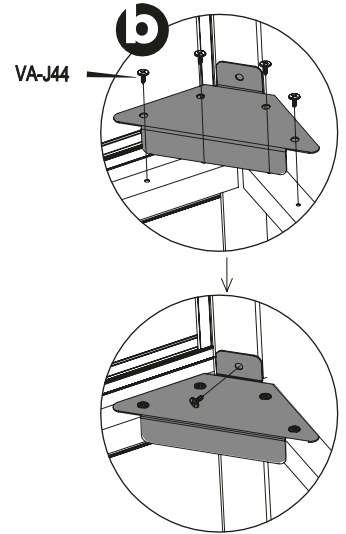
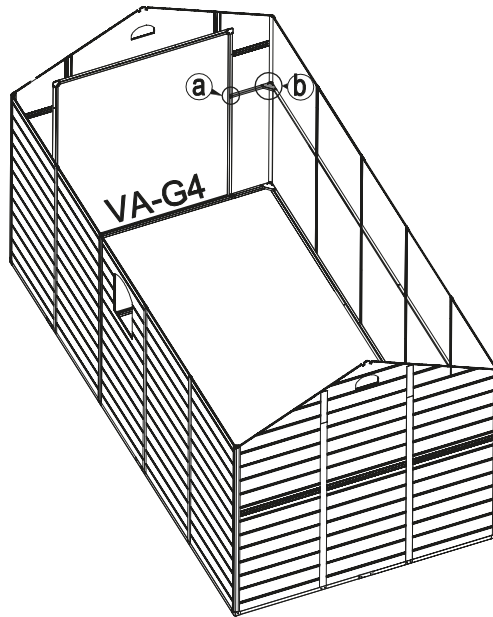
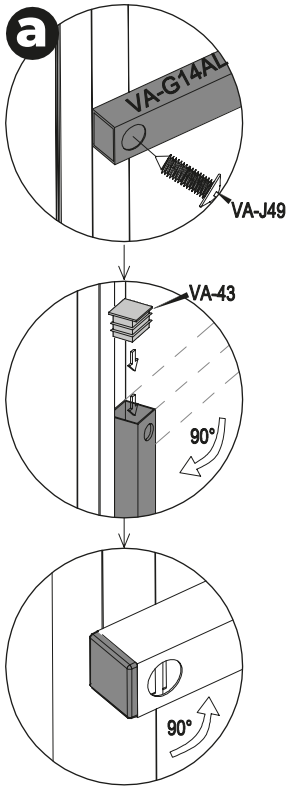

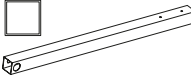
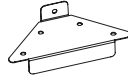
32	 VA-G14AL [x1] 345MM	 VA-30 [x1]	 VA-43 [x1]	 VA-J49 [x1] 13 MM	 VA-J44 [x5] 13 MM	
-----------	------------------------------------------------------------------------------------------------------------	------------------------------------------------------------------------------------------------	-------------------------------------------------------------------------------------------------	------------------------------------------------------------------------------------------------------------	------------------------------------------------------------------------------------------------------------	--

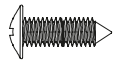

33	 VA-G14AR [x1] 345MM	 VA-30 [x1]	 VA-43 [x1]	 VA-J49 [x1] 13 MM	 VA-J44 [x5] 13 MM	
-----------	---------------------------------------------------------------------------------------------------------------	---------------------------------------------------------------------------------------------------	---------------------------------------------------------------------------------------------------	--------------------------------------------------------------------------------------------------------------	---------------------------------------------------------------------------------------------------------------	--

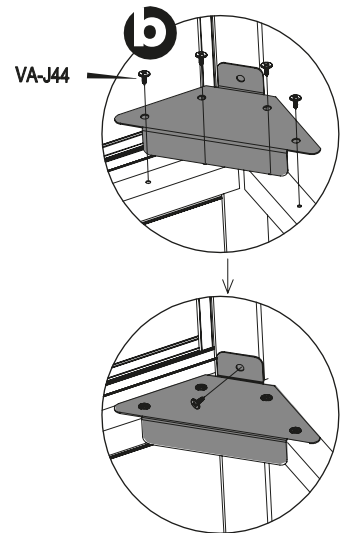
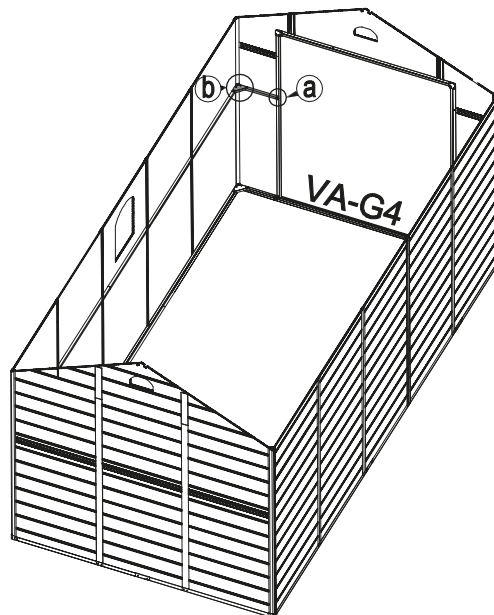
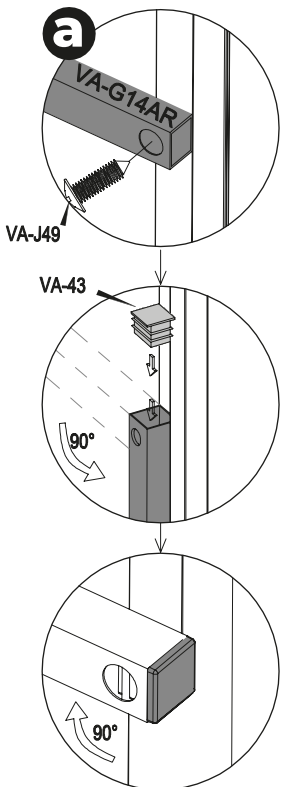



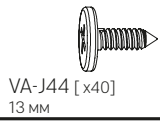

34

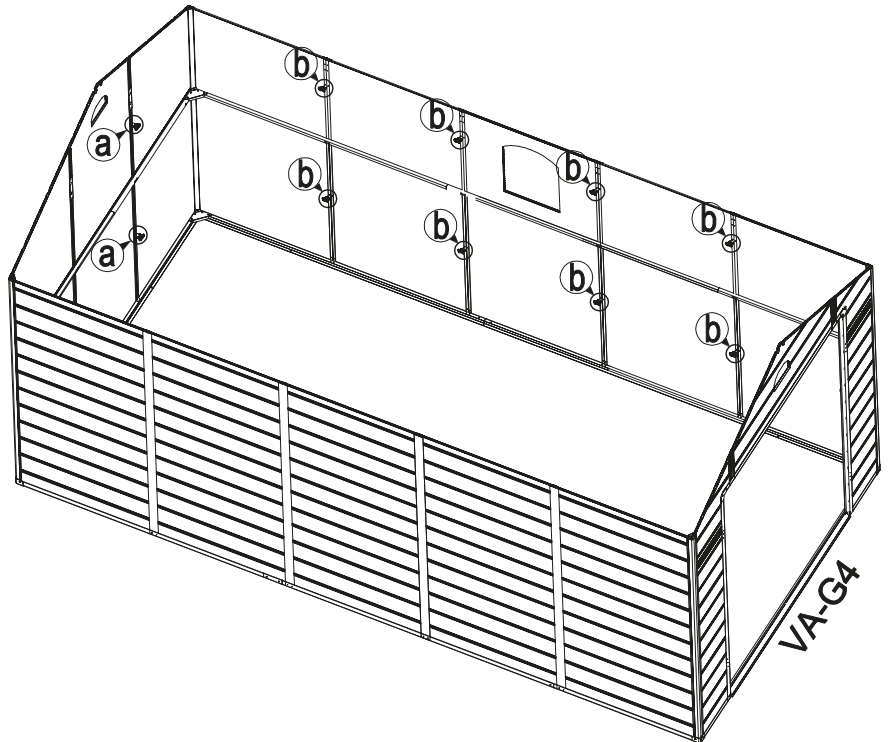
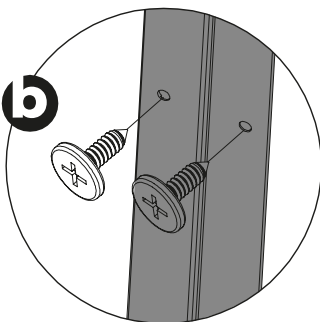
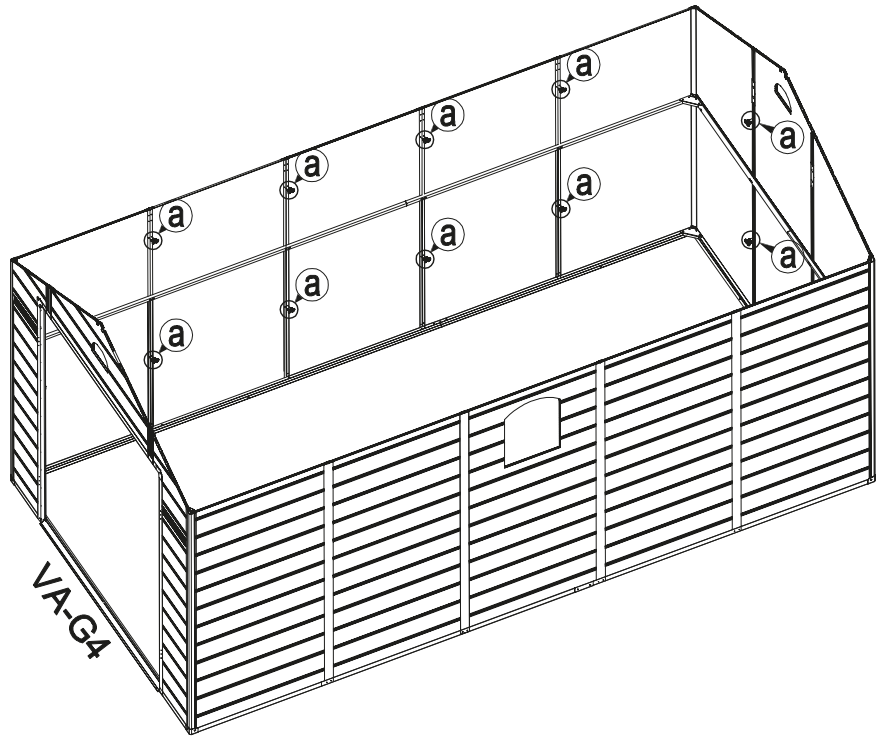
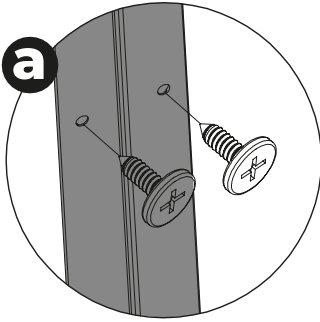

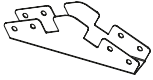

VA-J44 [x40]
13 mm

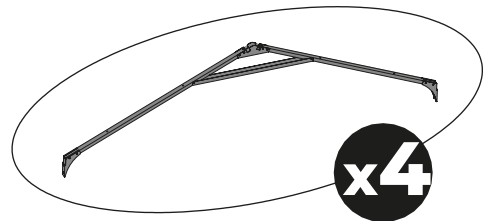
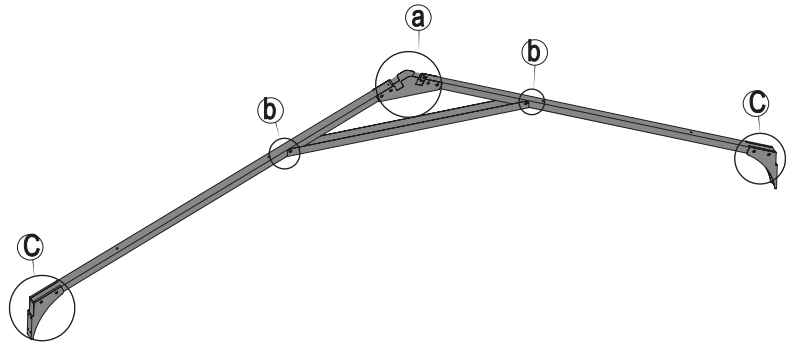
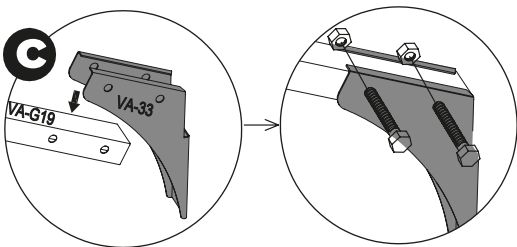
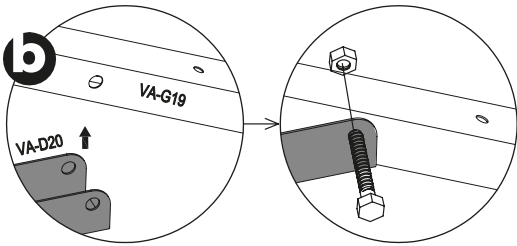
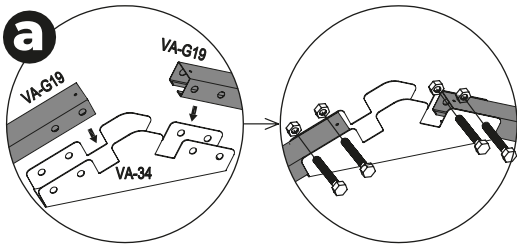

35	 VA-34 [x4]	 VA-33 [x8]	 VA-G19 [x8] 1181 mm	 VA-D20 [x4] 725 mm	 VA-J50 [x40] 40 mm	
-----------	------------------------------------------------------------------------------------------------	-------------------------------------------------------------------------------------------------	-------------------------------------------------------------------------------------------------------------	-------------------------------------------------------------------------------------------------------------	-------------------------------------------------------------------------------------------------------------	--

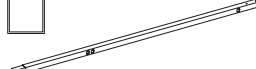

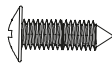
36	 VA-E17 [x2] 977 mm	 VA-E18 [x2] 1745 mm	 VA-J18 [x2] 1805 mm	 VA-J46 [x12] 13 mm	
-----------	--------------------------------------------------------------------------------------------------------------	---------------------------------------------------------------------------------------------------------------	----------------------------------------------------------------------------------------------------------------	----------------------------------------------------------------------------------------------------------------	--

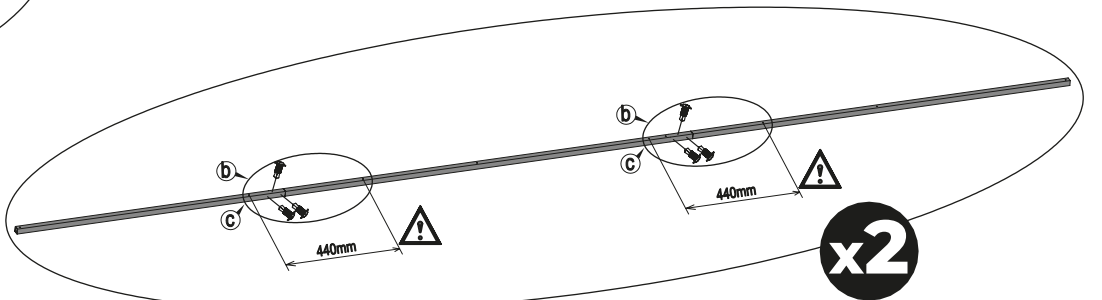
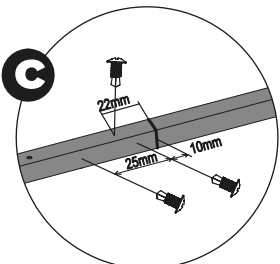
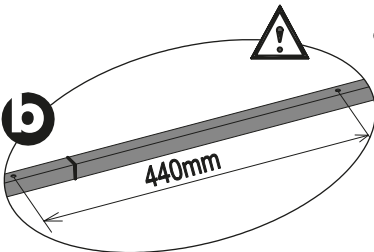
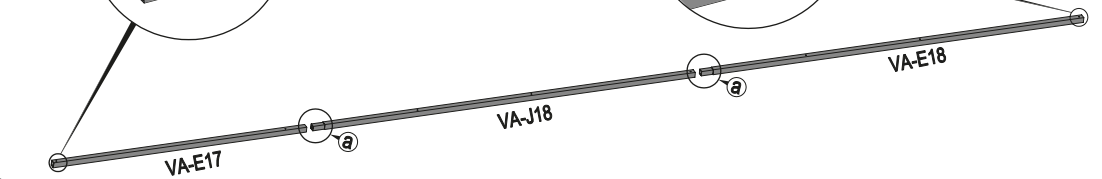
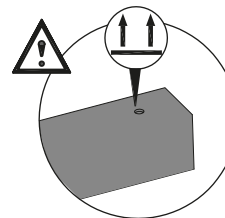
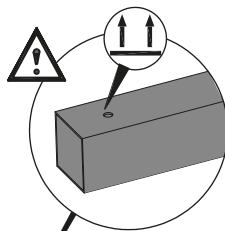
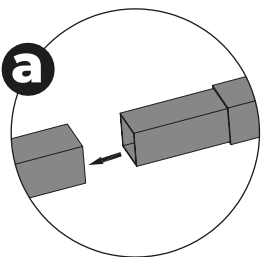

37

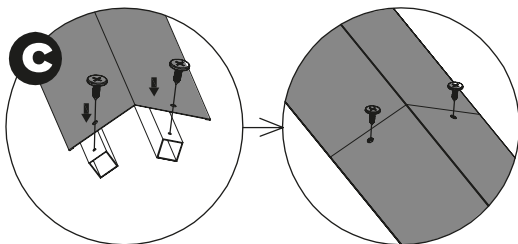
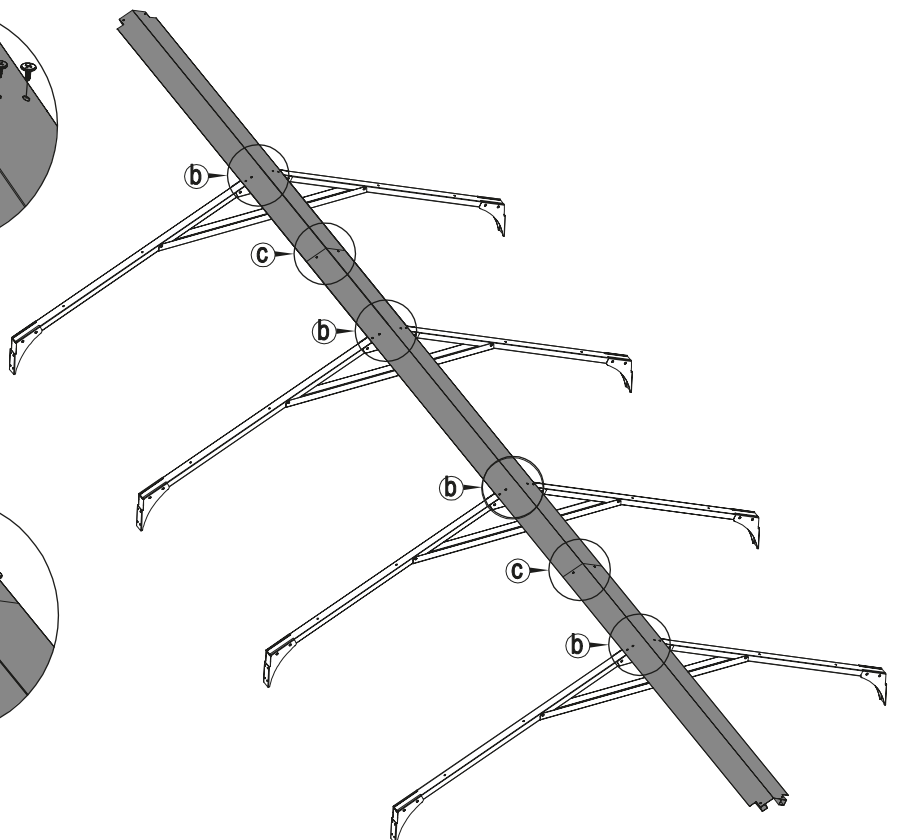
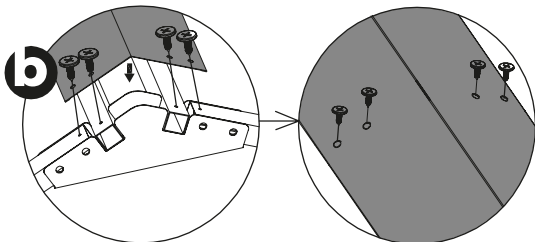
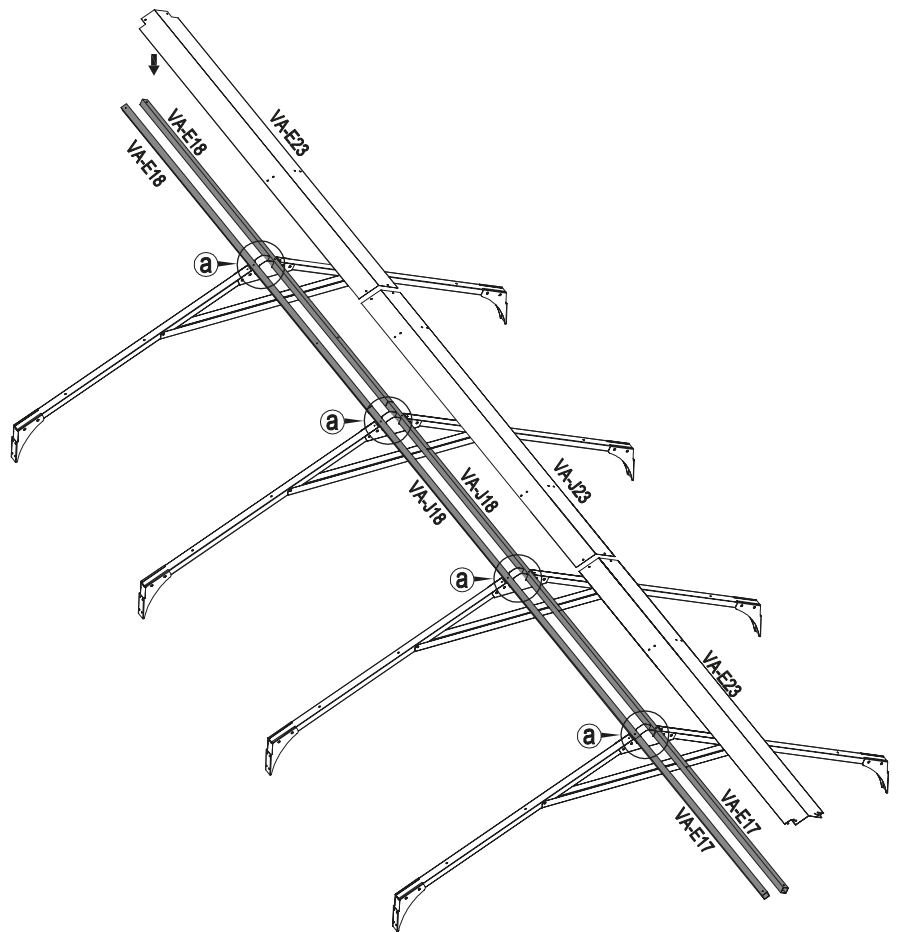
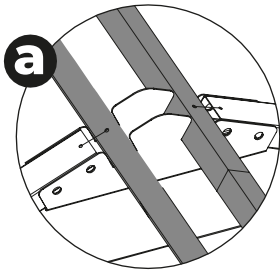
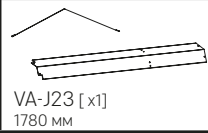
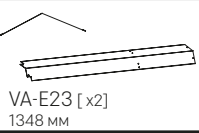

38

VA-35 [x2]

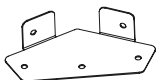

VA-J44 [x42]
13 MM

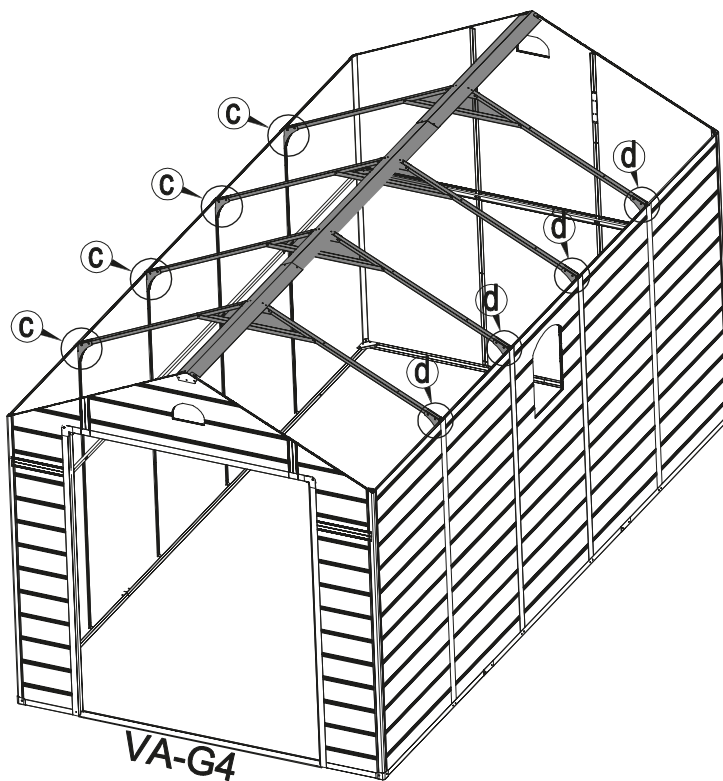
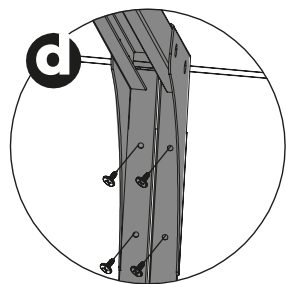
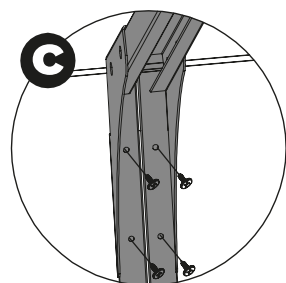
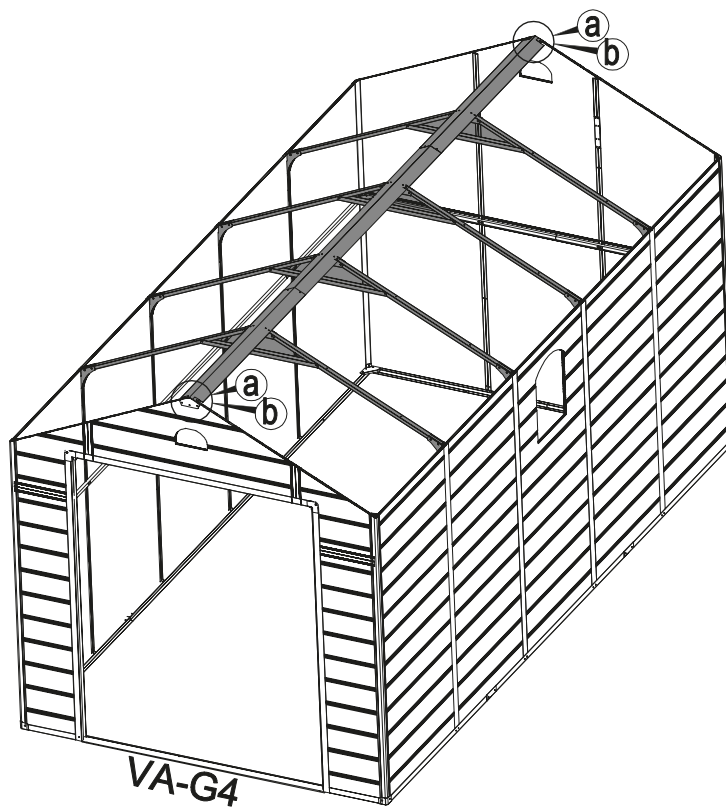
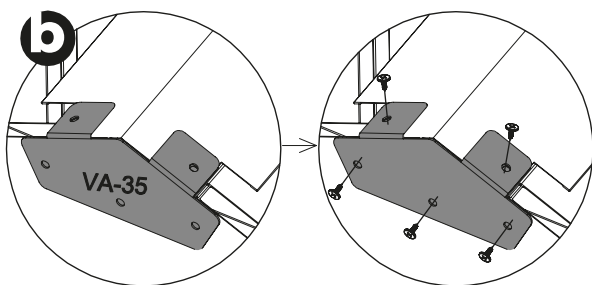
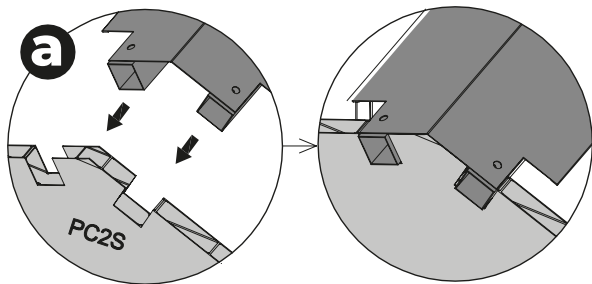
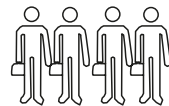



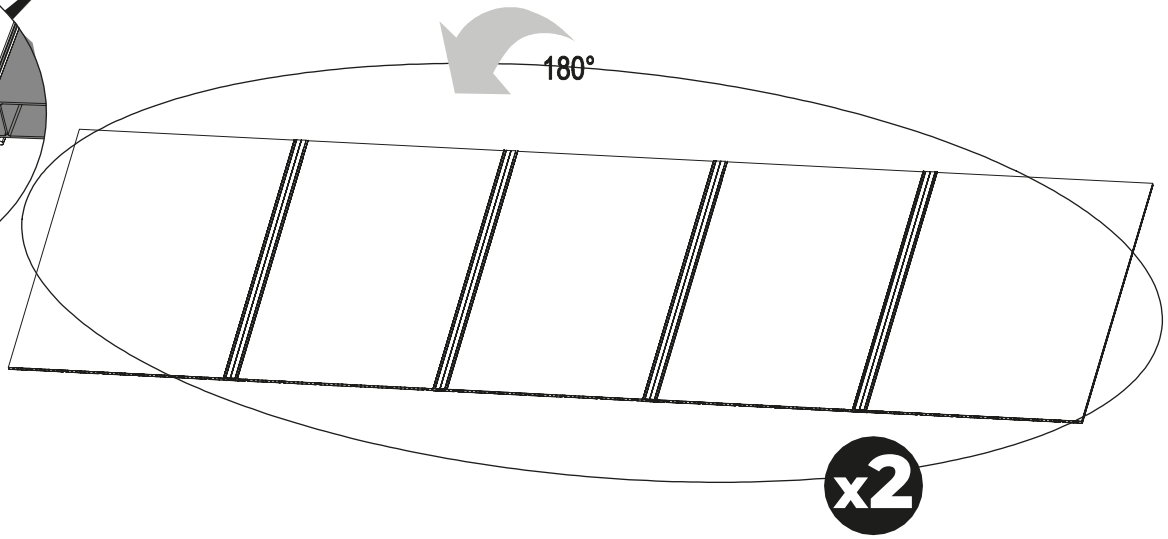
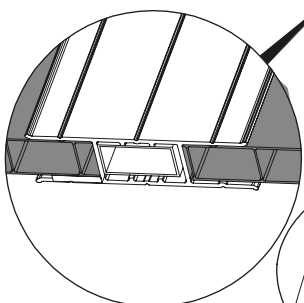
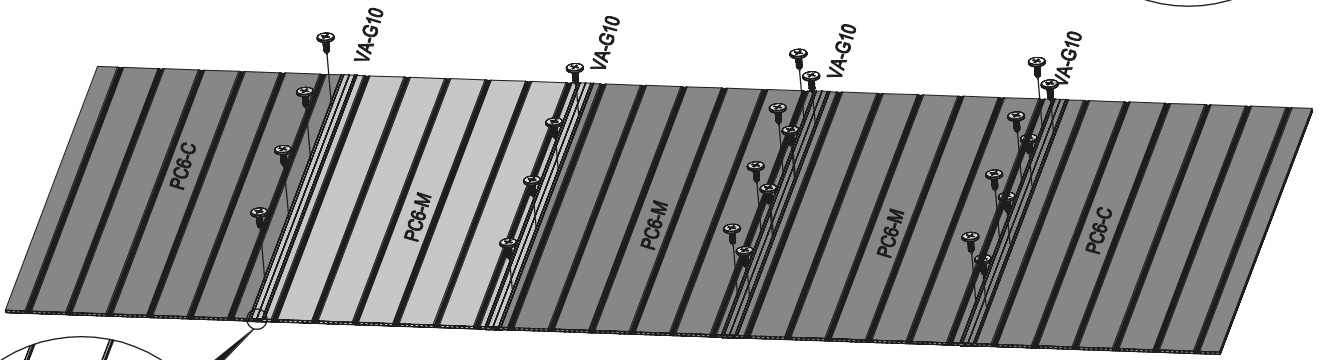
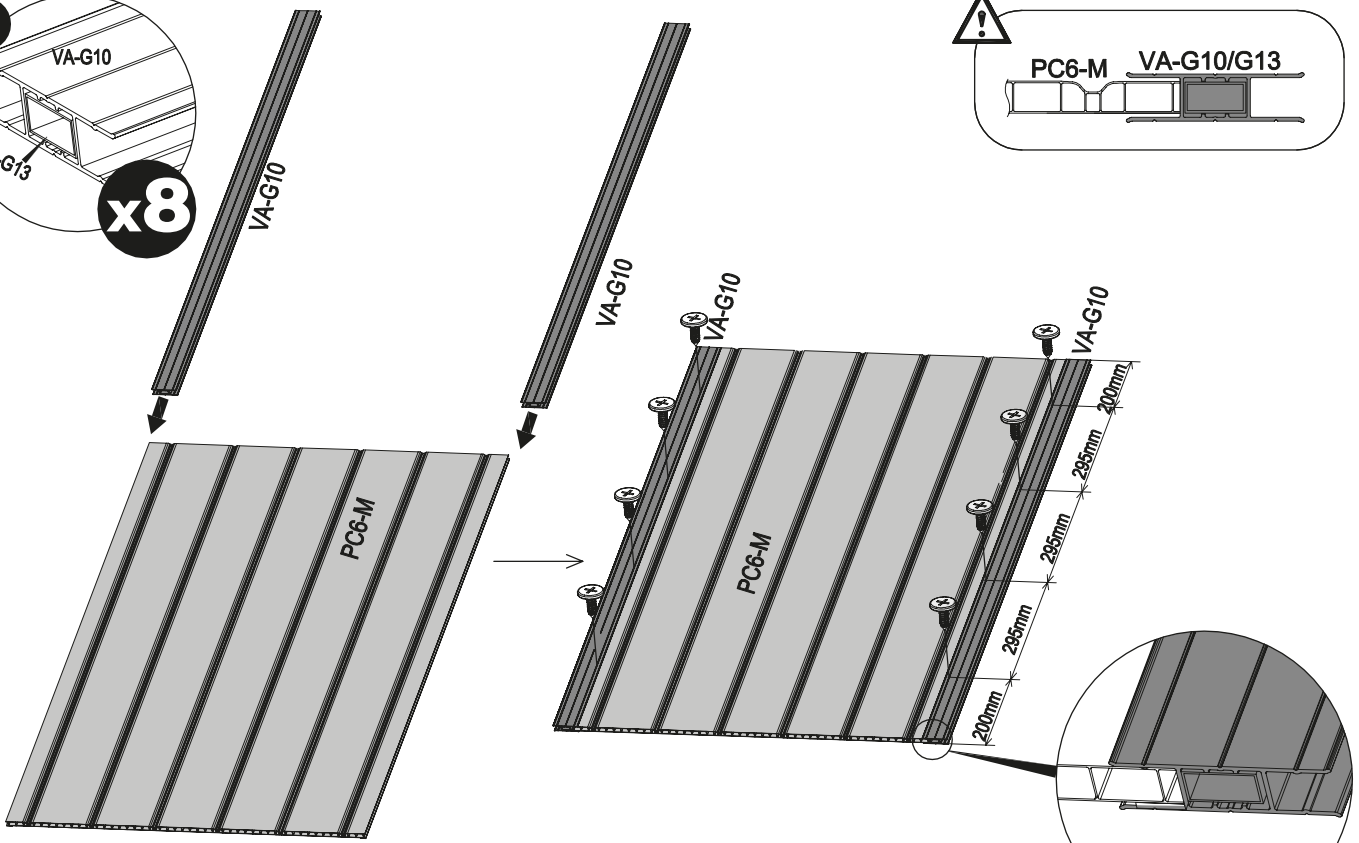
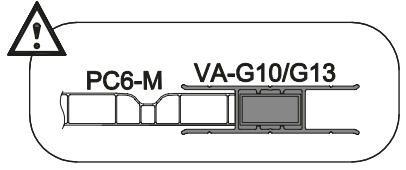
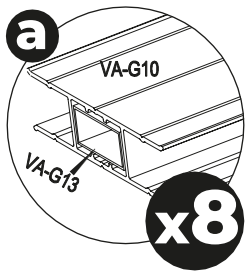
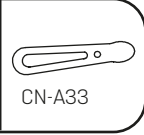
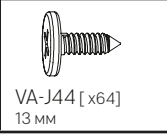
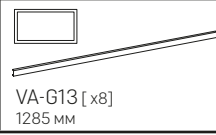
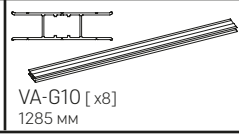
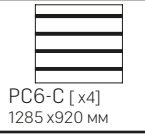
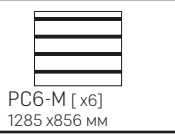

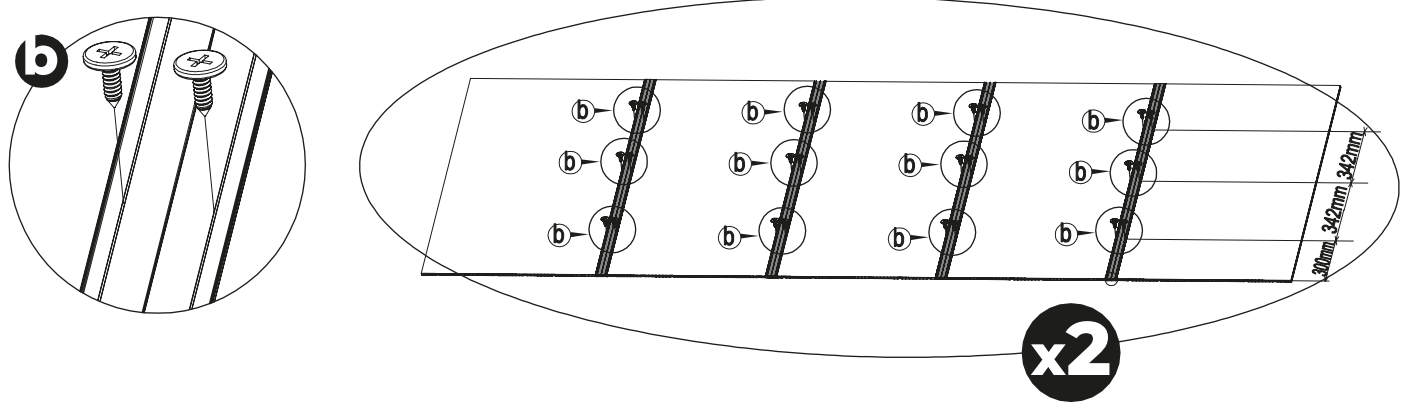
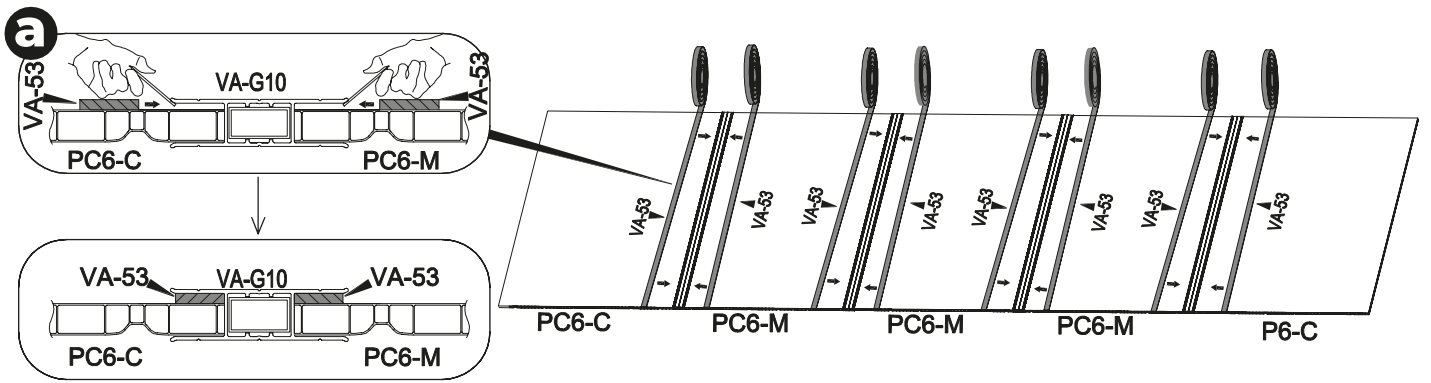

39



40	 VA-53 [x4]	 VA-J44 [x48] 13 MM		 CN-A33
-----------	------------------------------------------------------------------------------------------------	-----------------------------------------------------------------------------------------------------------	--	-----------------------------------------------------------------------------------------------



41	 VA-E22 [x4] 1282 MM	 VA-J22 [x2] 1740 MM	 Ø8mm	
-----------	---------------------------------------------------------------------------------------------------------------	---------------------------------------------------------------------------------------------------------------	---------------------------------------------------------------------------------------------	--

	VA-E22 [x4] ✓ 1282mm 	VA-G21 [x4] ✗ 1165mm 
	VA-J22 [x2] ✓ 1740mm 	

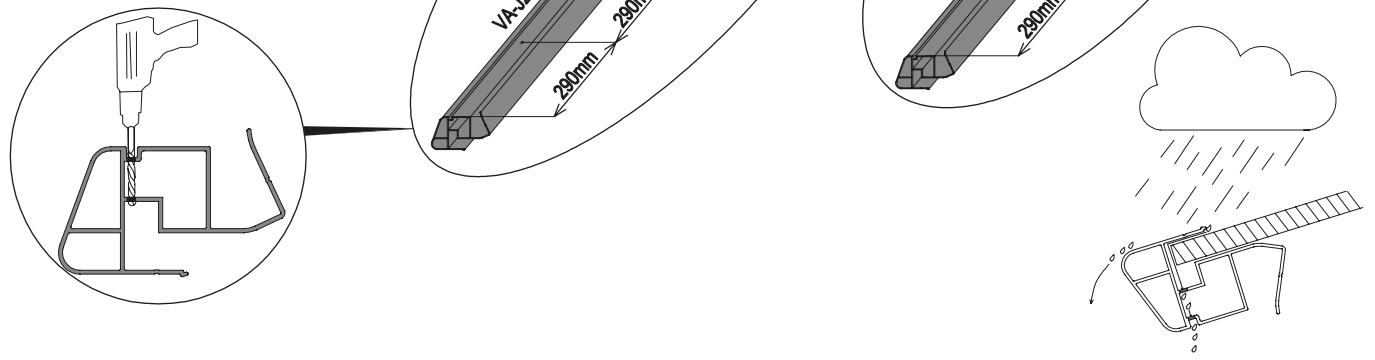

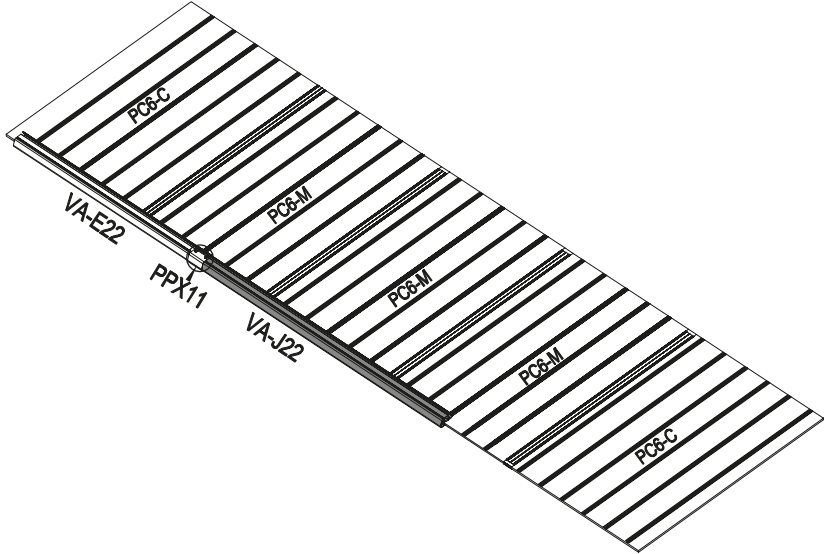
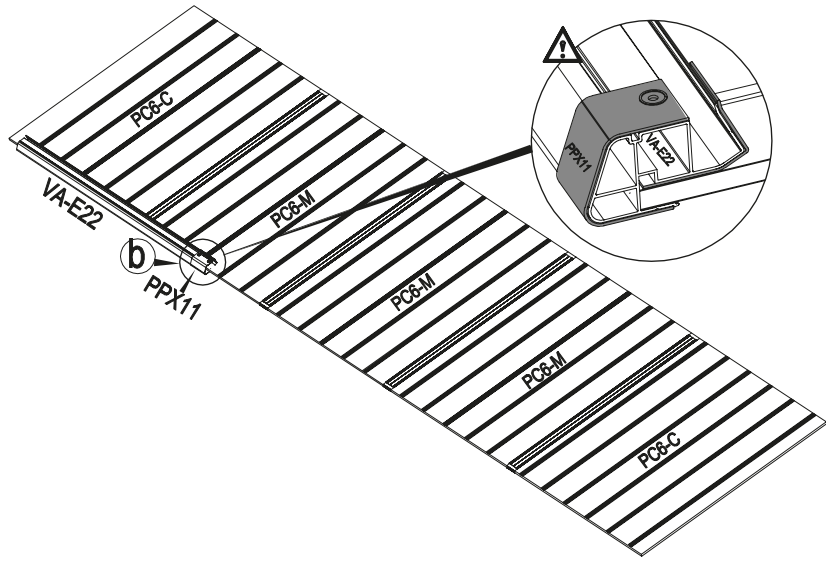
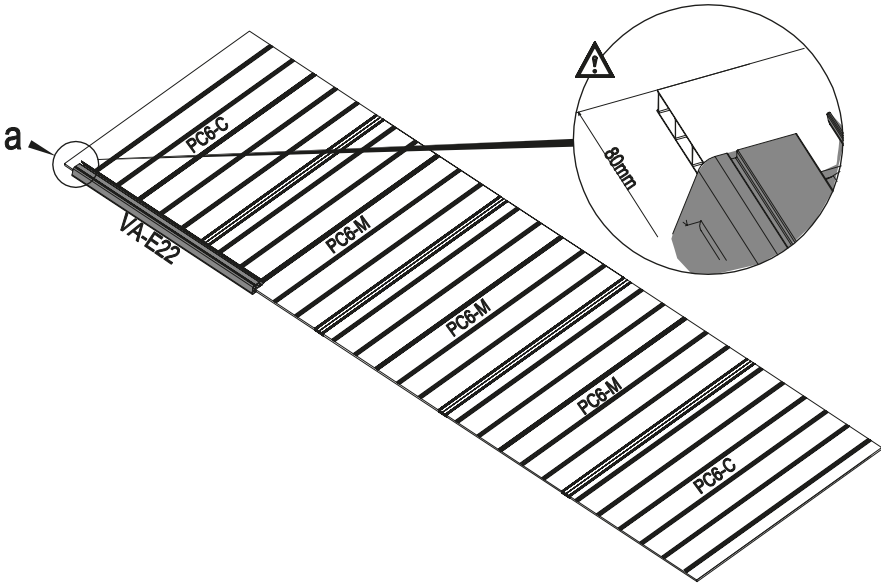
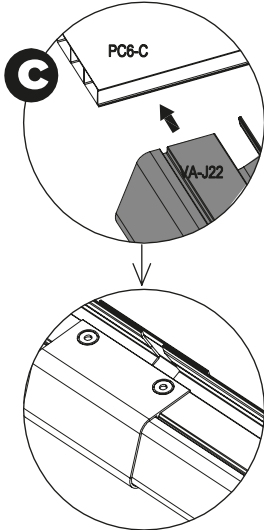
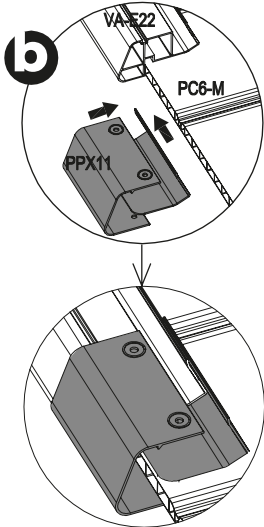
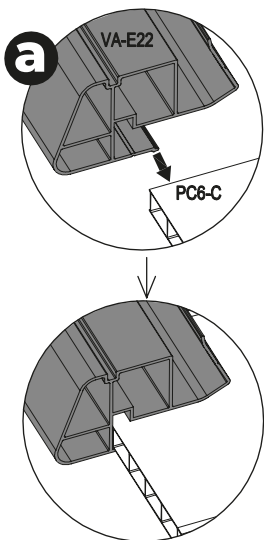
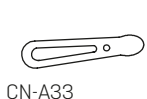
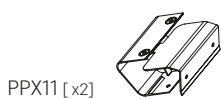
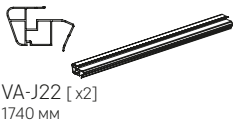
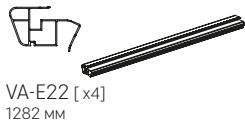

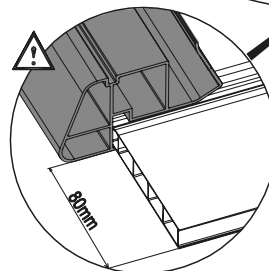
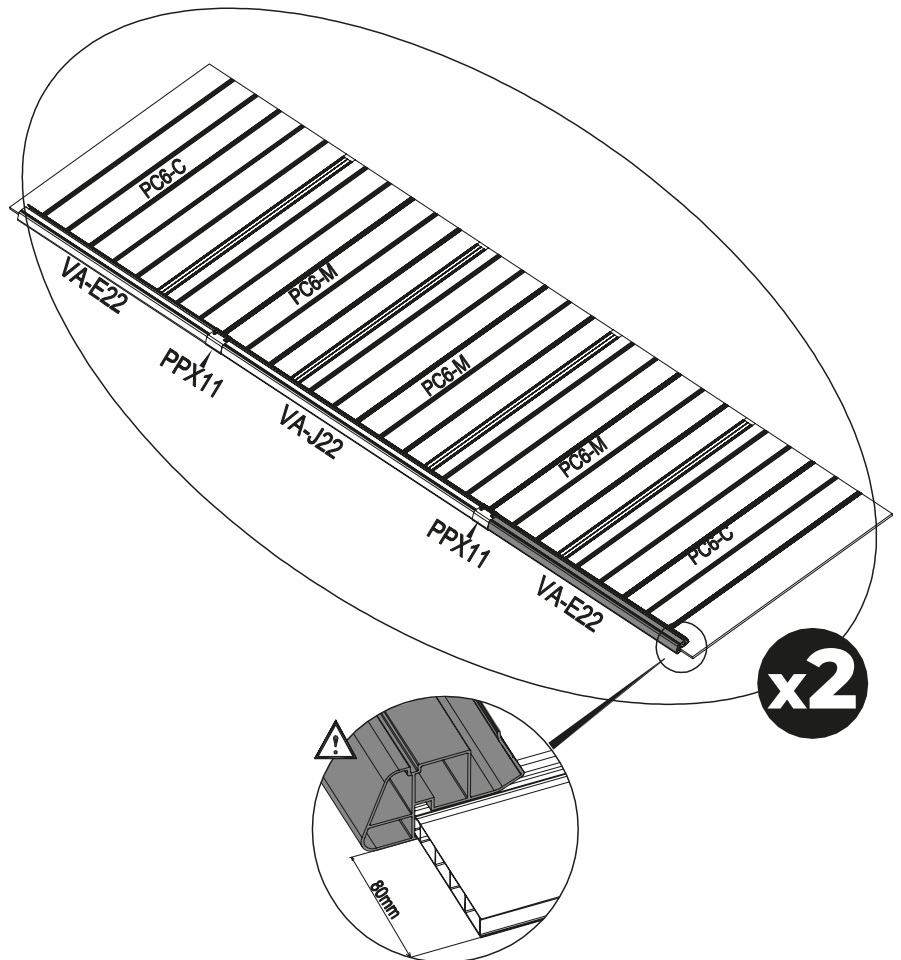
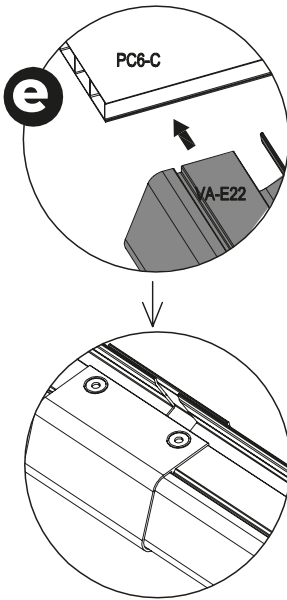
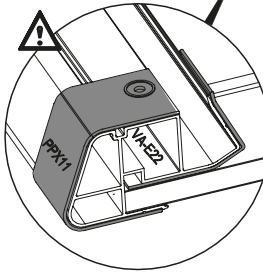
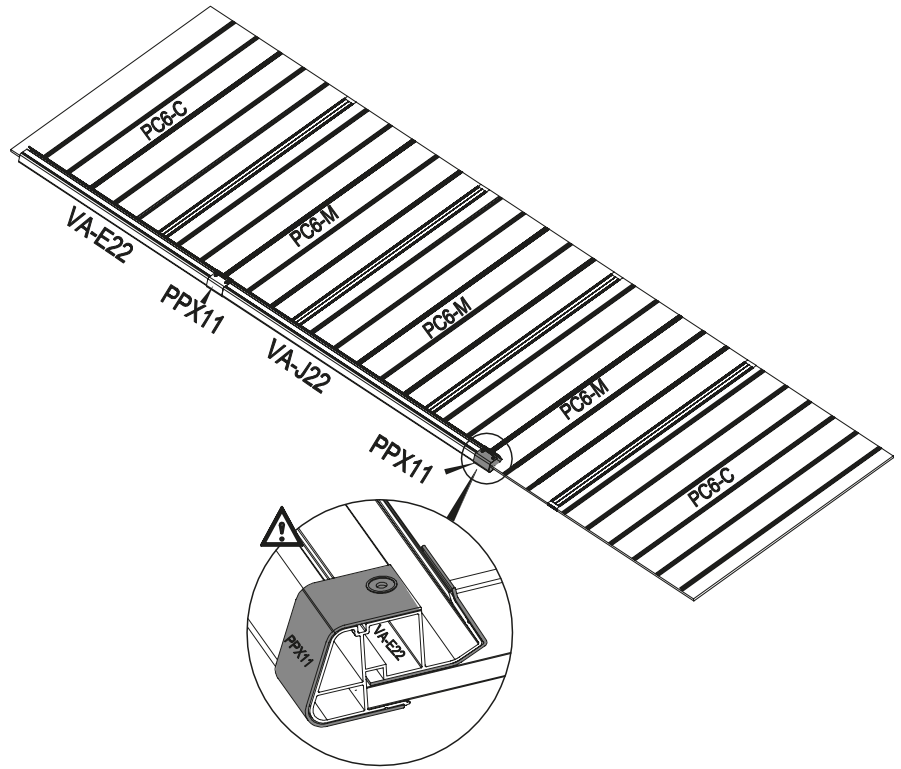
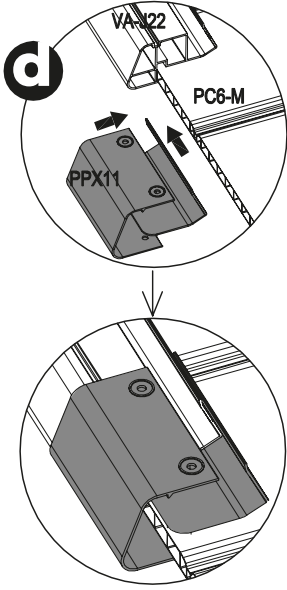

43

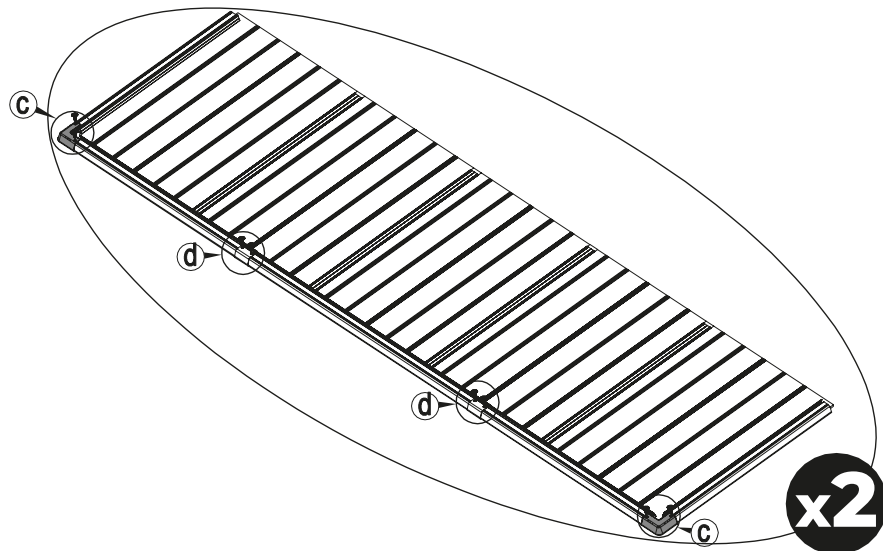
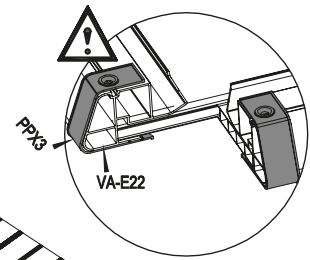
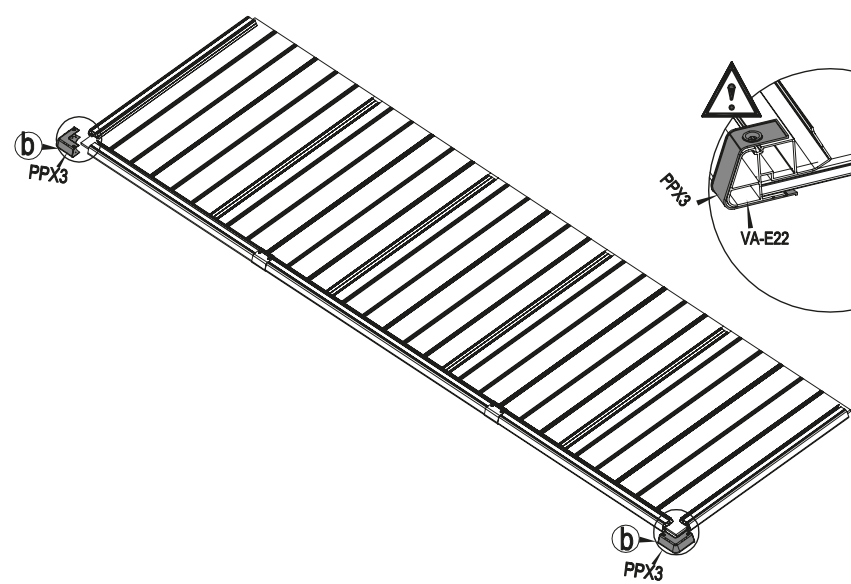
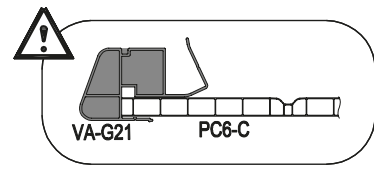
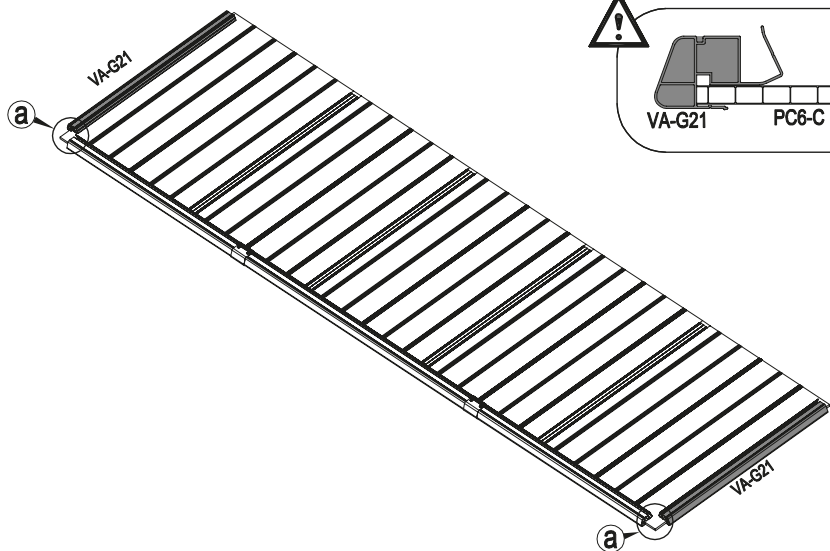
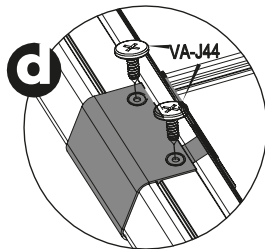
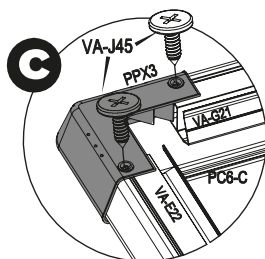
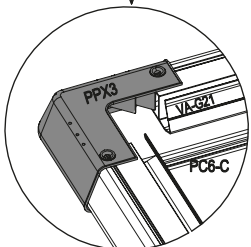
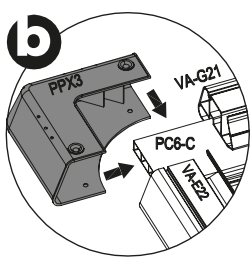
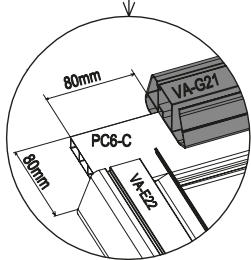
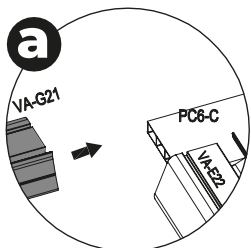
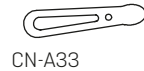
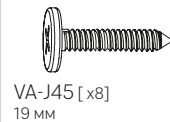
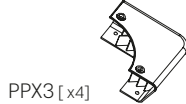
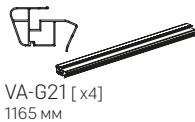

44

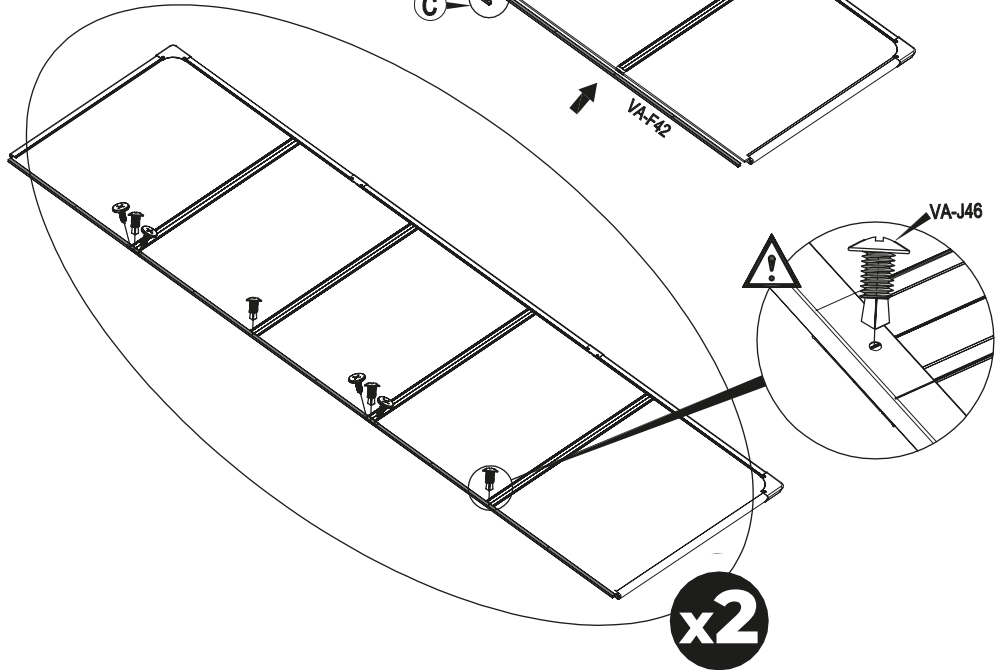
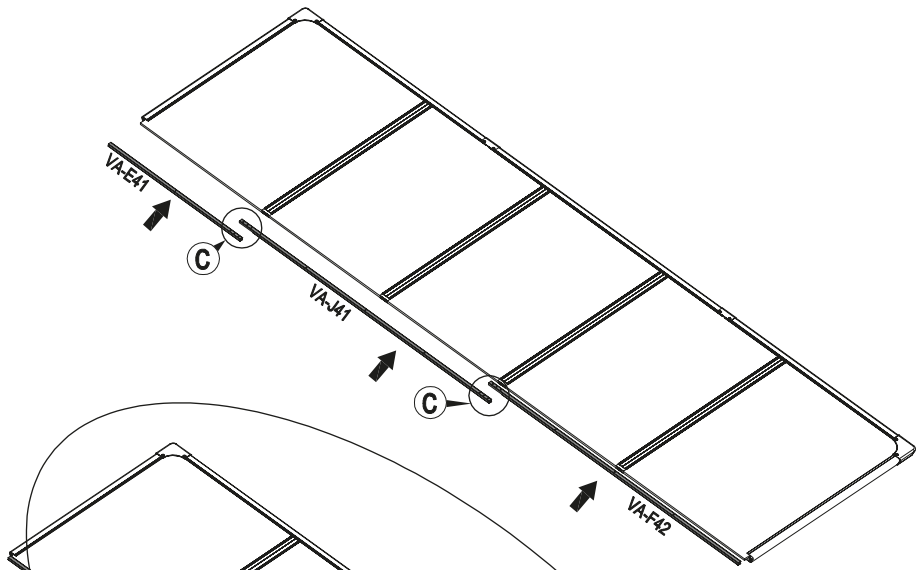
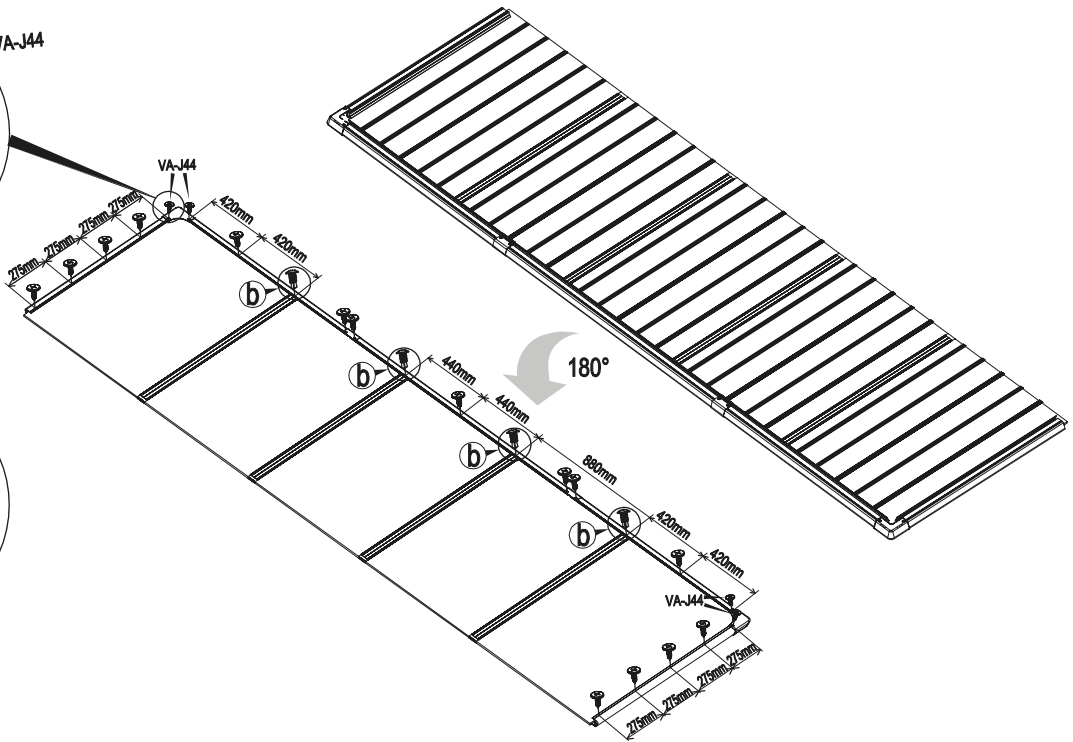
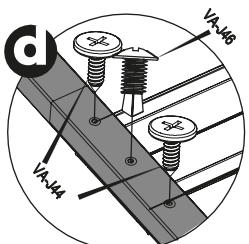
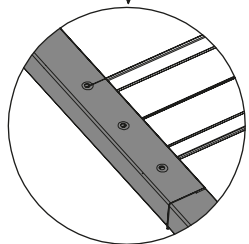
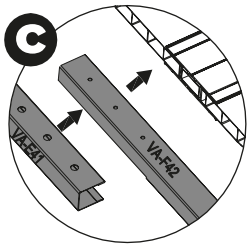
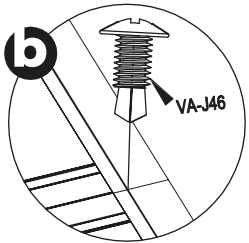
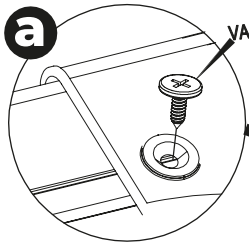
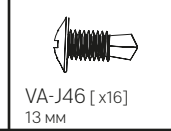
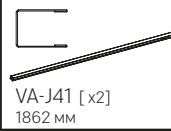
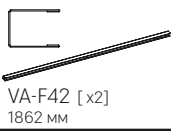

x2

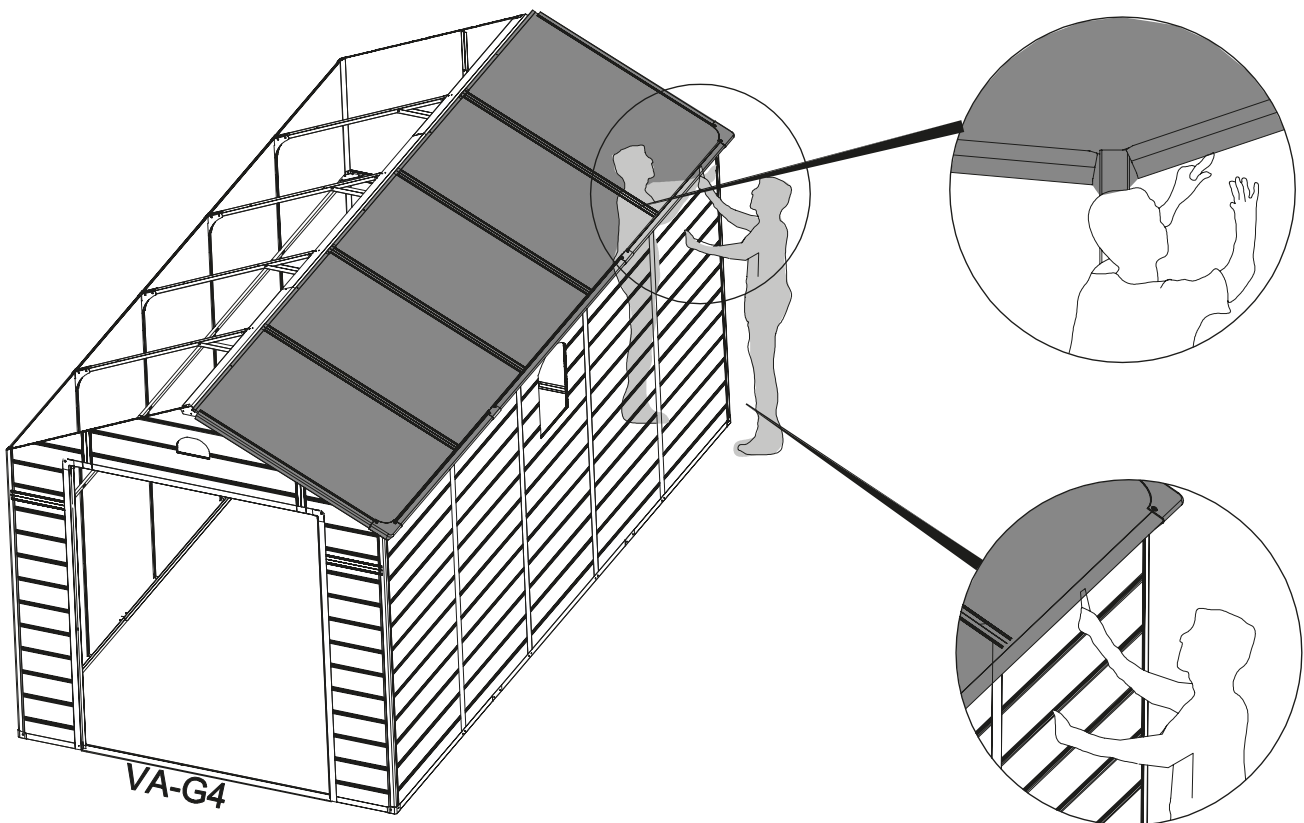
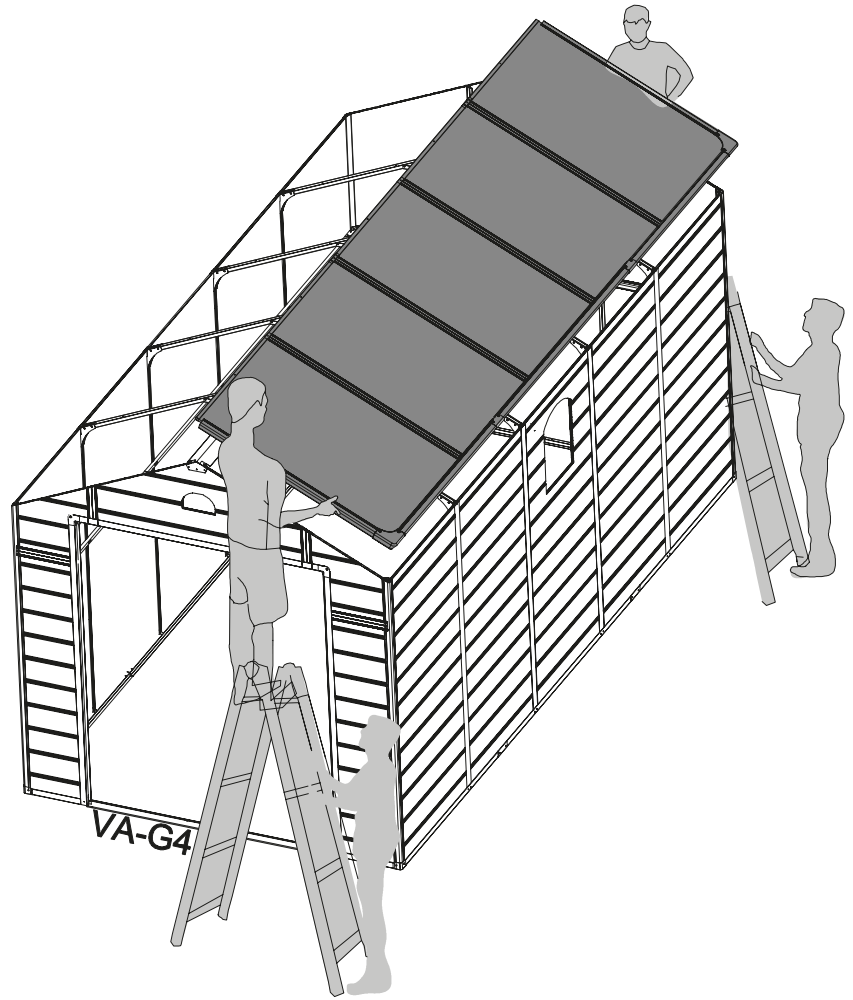
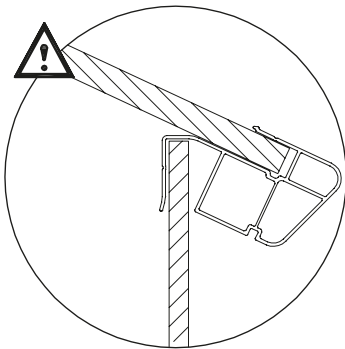
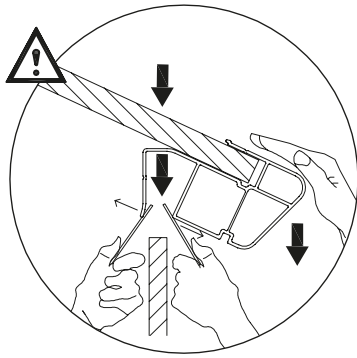
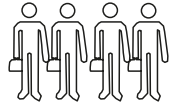

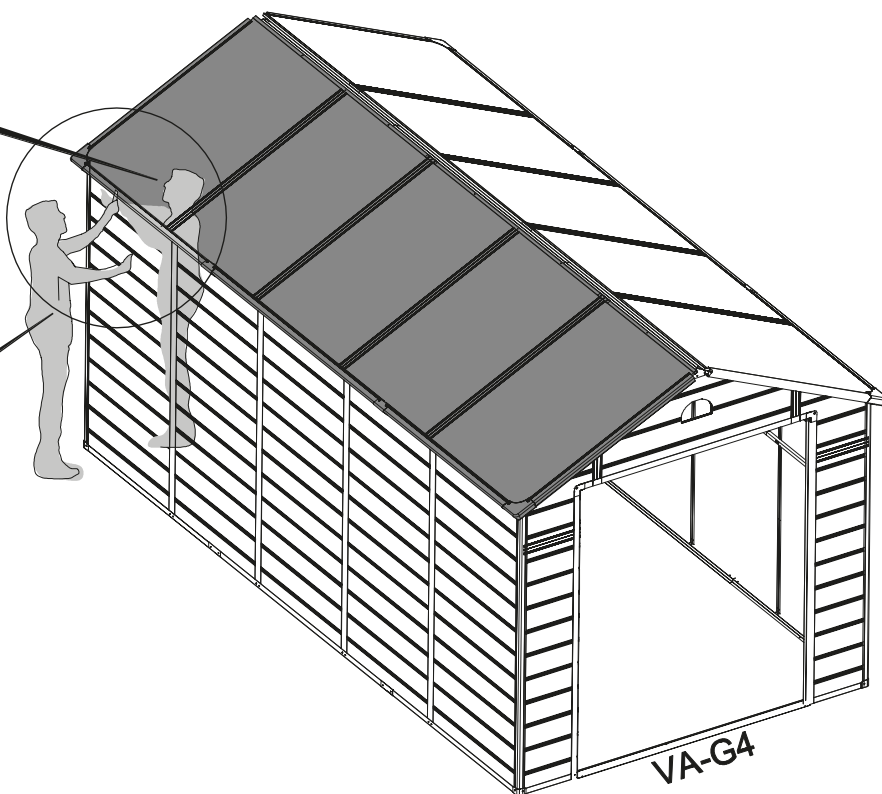
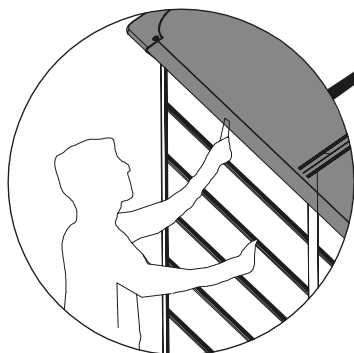
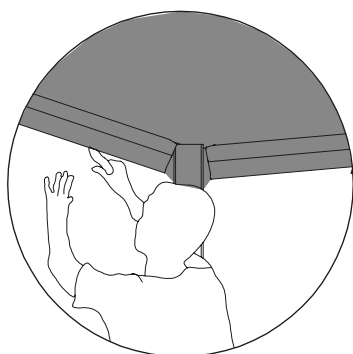
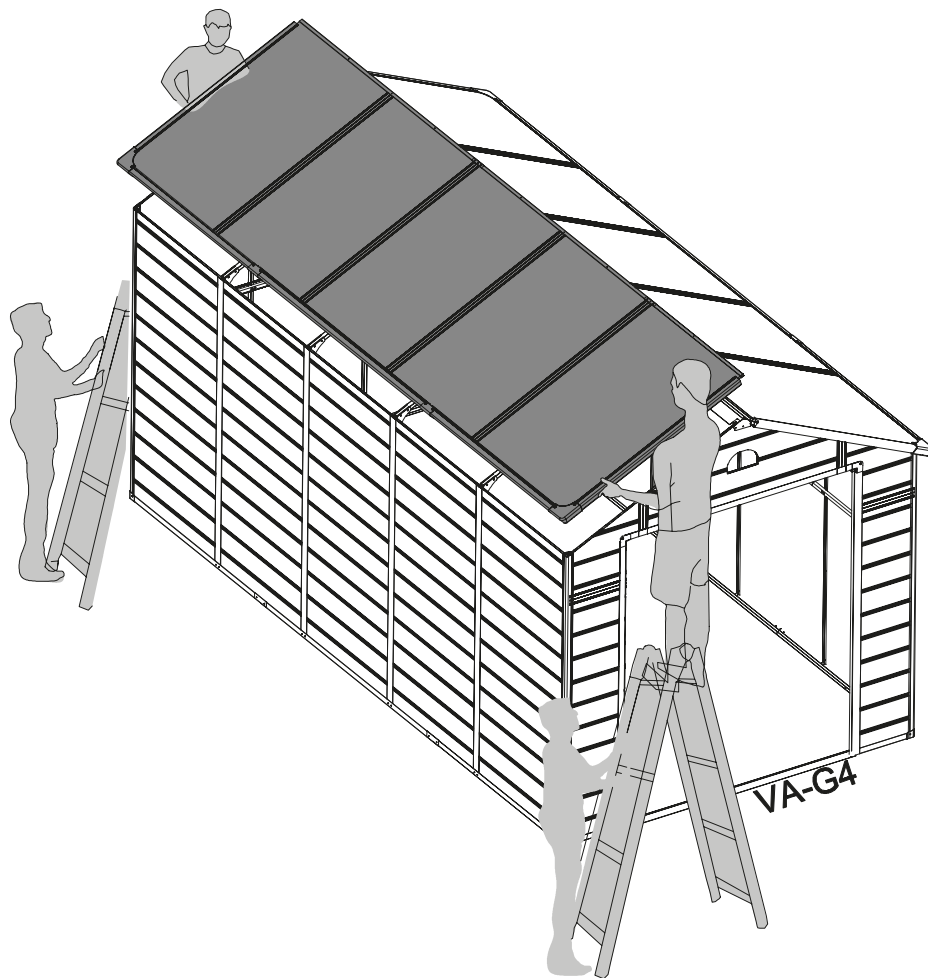
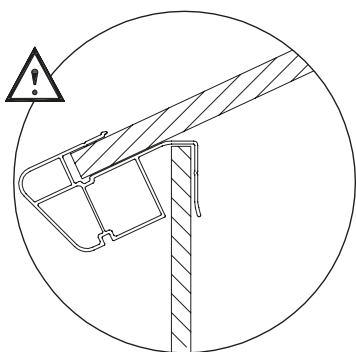
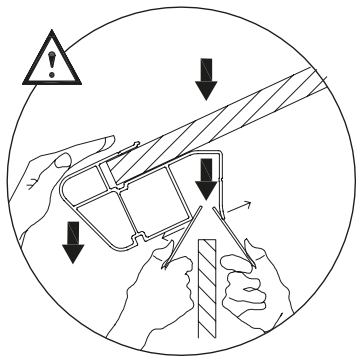
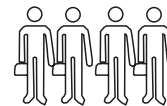

47



VA-J45 [x44]
19 MM



VA-J46 [x16]
13 MM

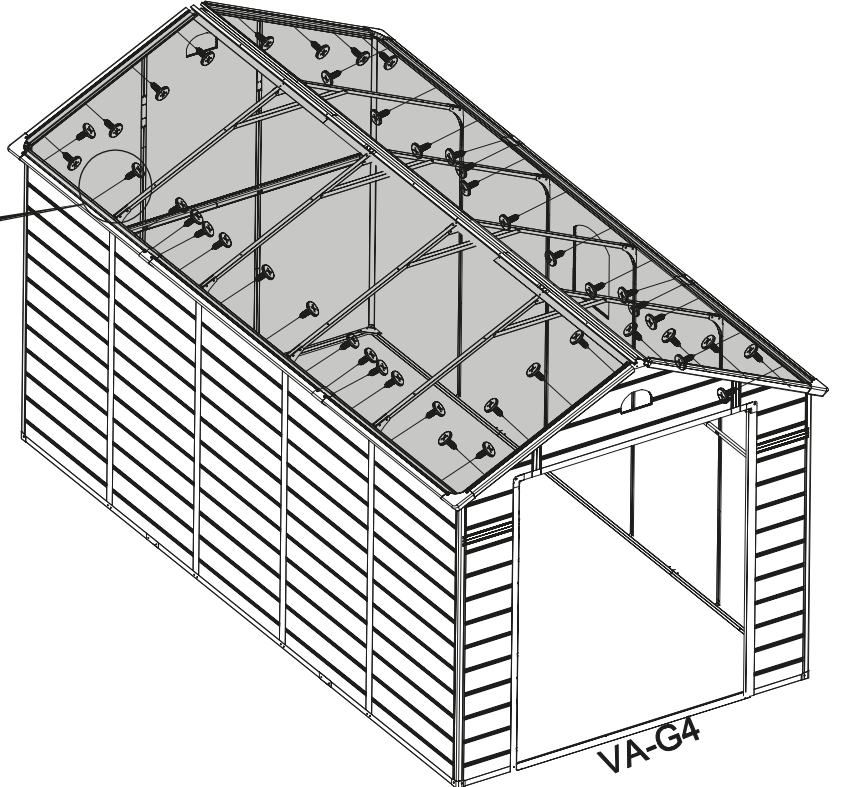
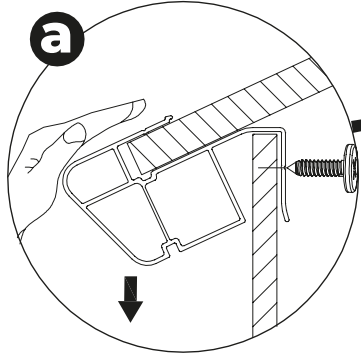

VA-G4

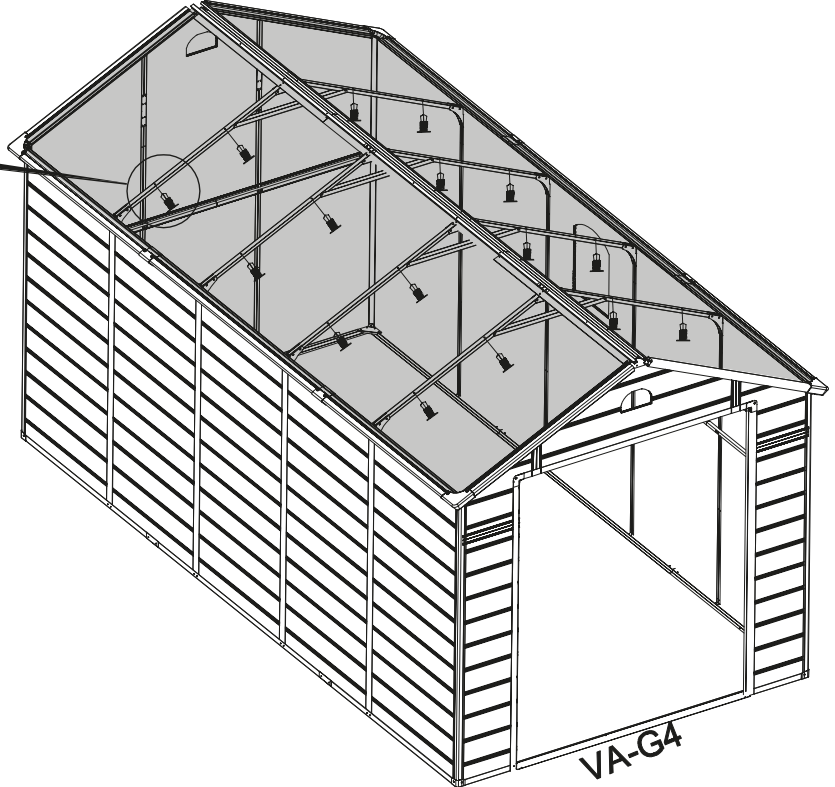
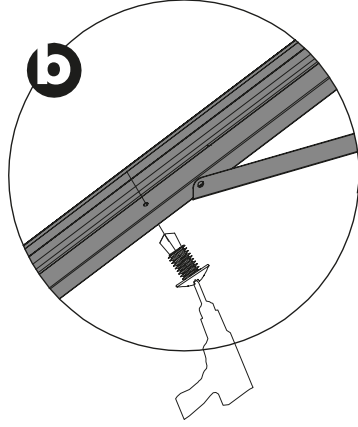

VA-G4

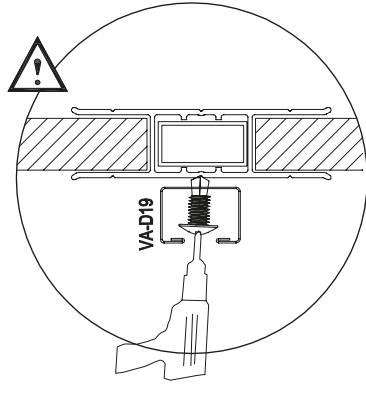

VA-D19

48

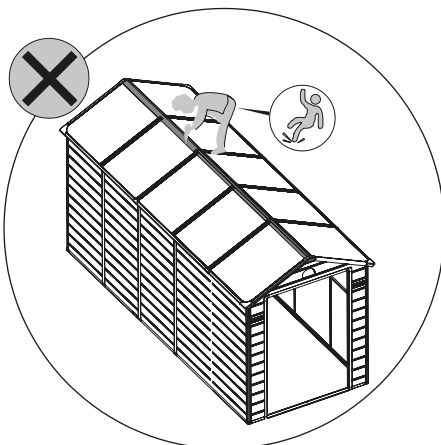
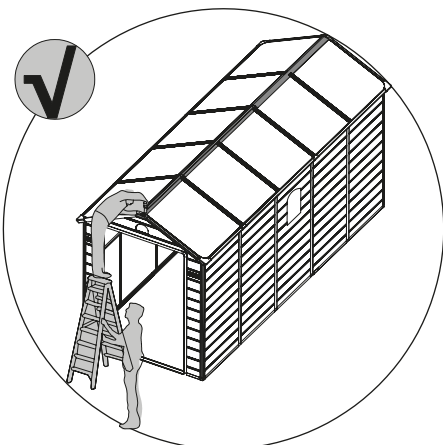
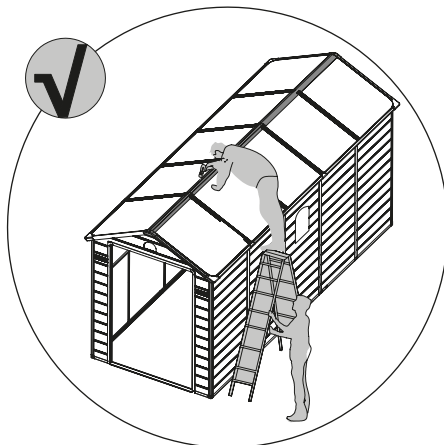
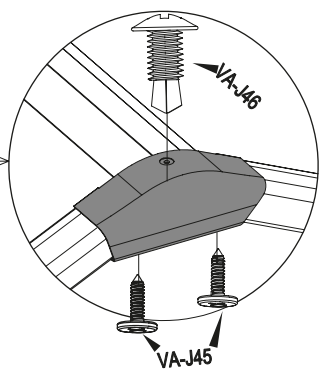
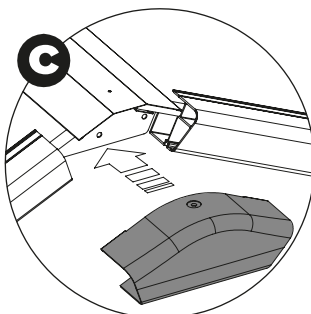
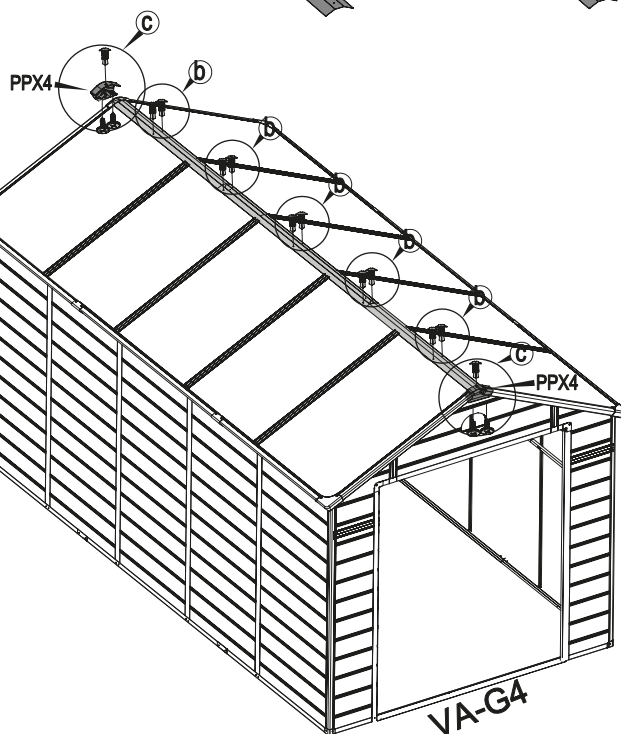
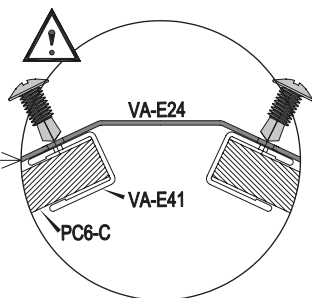
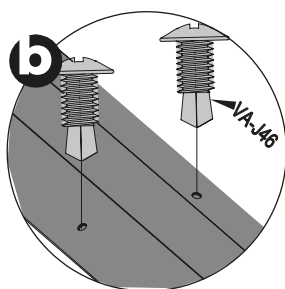
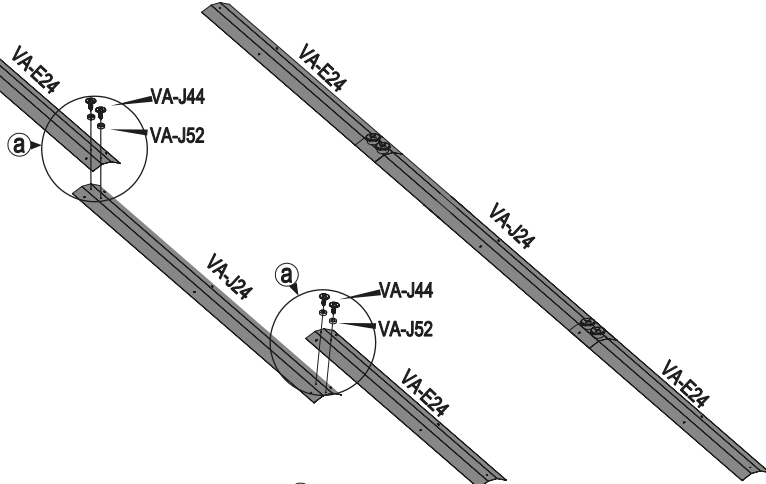
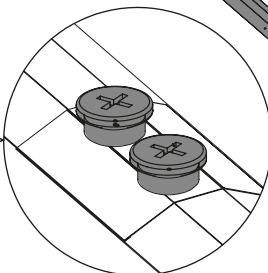
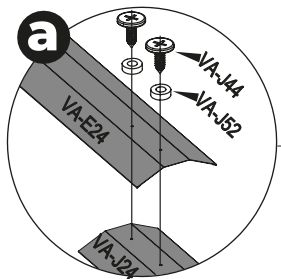
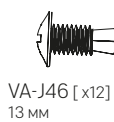
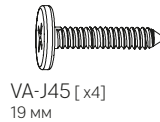
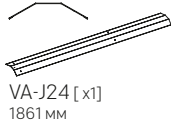
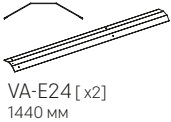

49

PC7S [x1]
1810x746 mm



VA-C29 [x1]
1812 mm



VA-C27 [x1]
1812 mm



VA-C28 [x2]
592 mm

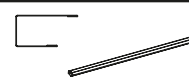

VA-J44 [x14]
13 mm

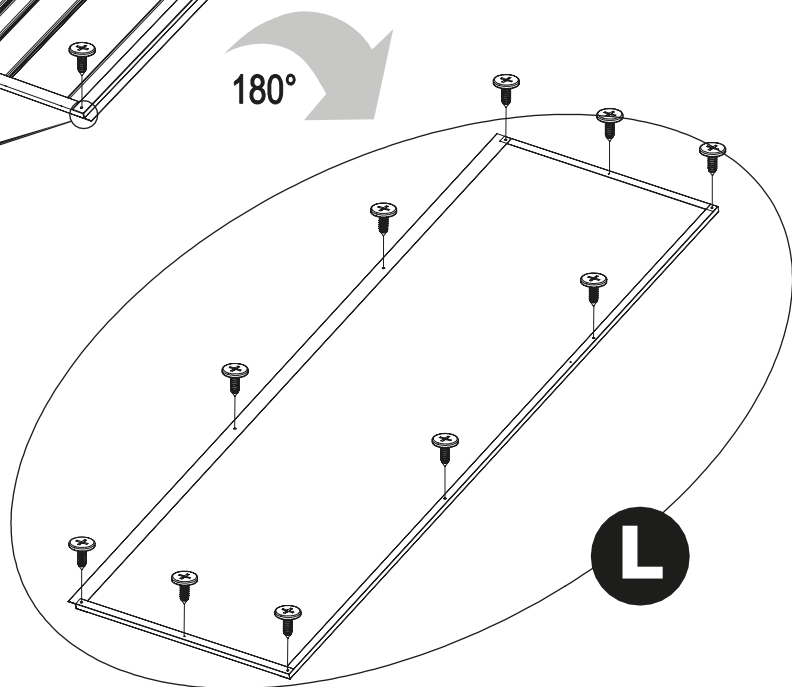
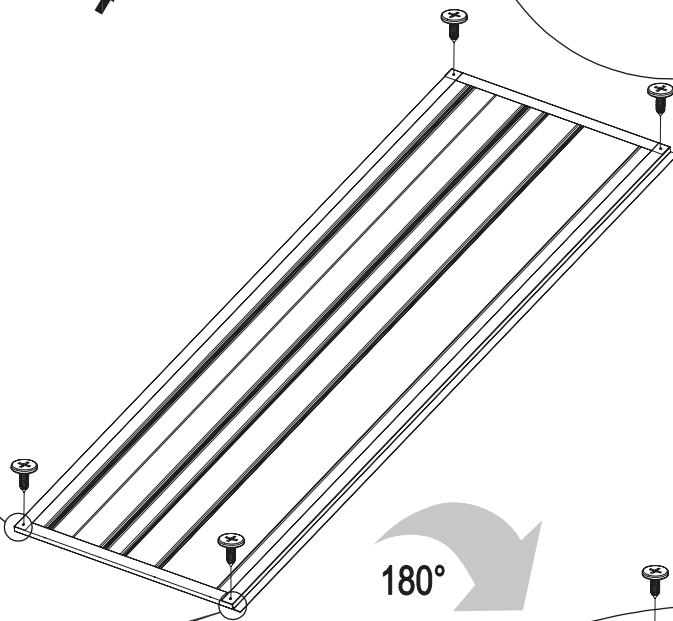
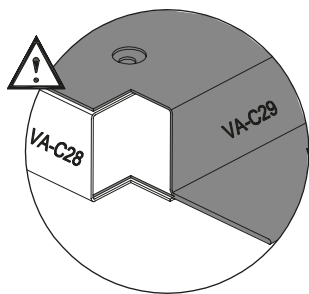
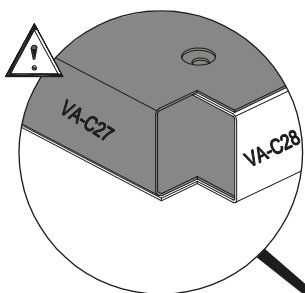
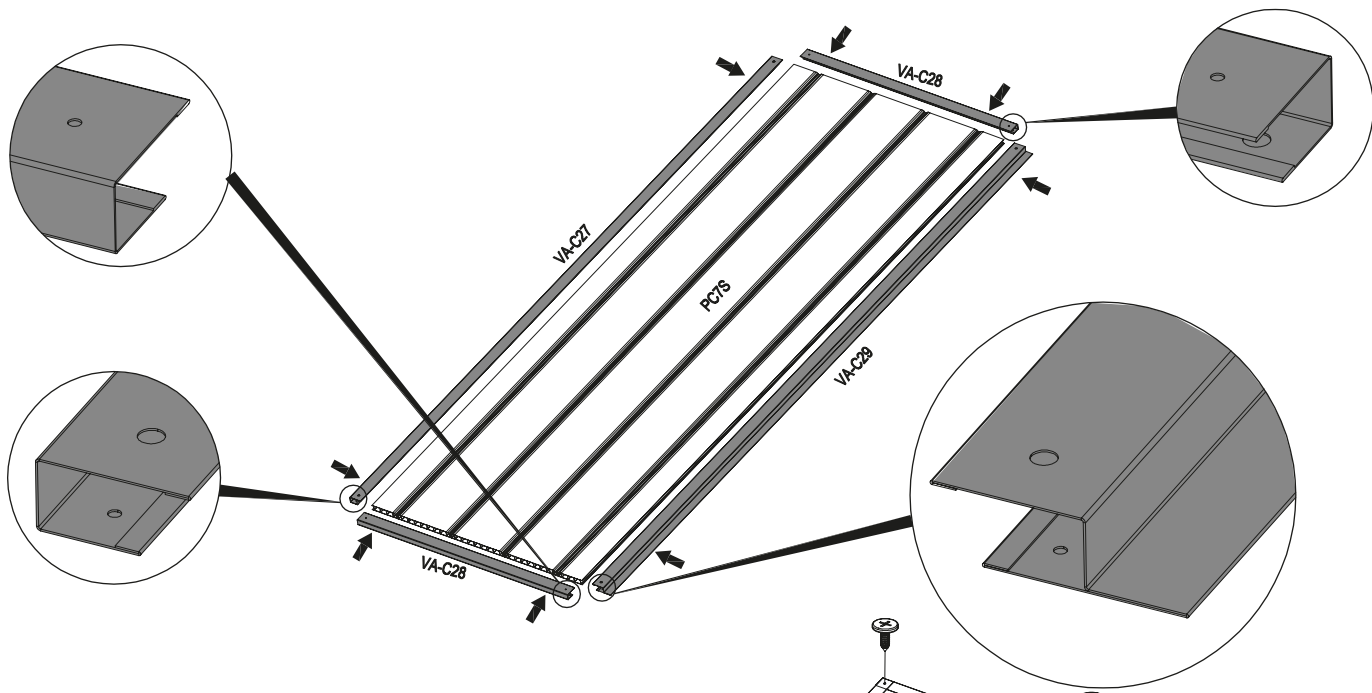

40

50

PC7S [x1]
1810x746 MM



VA-C27 [x2]
1812 MM



VA-C28 [x2]
592 MM



VA-J44 [x14]
13 MM

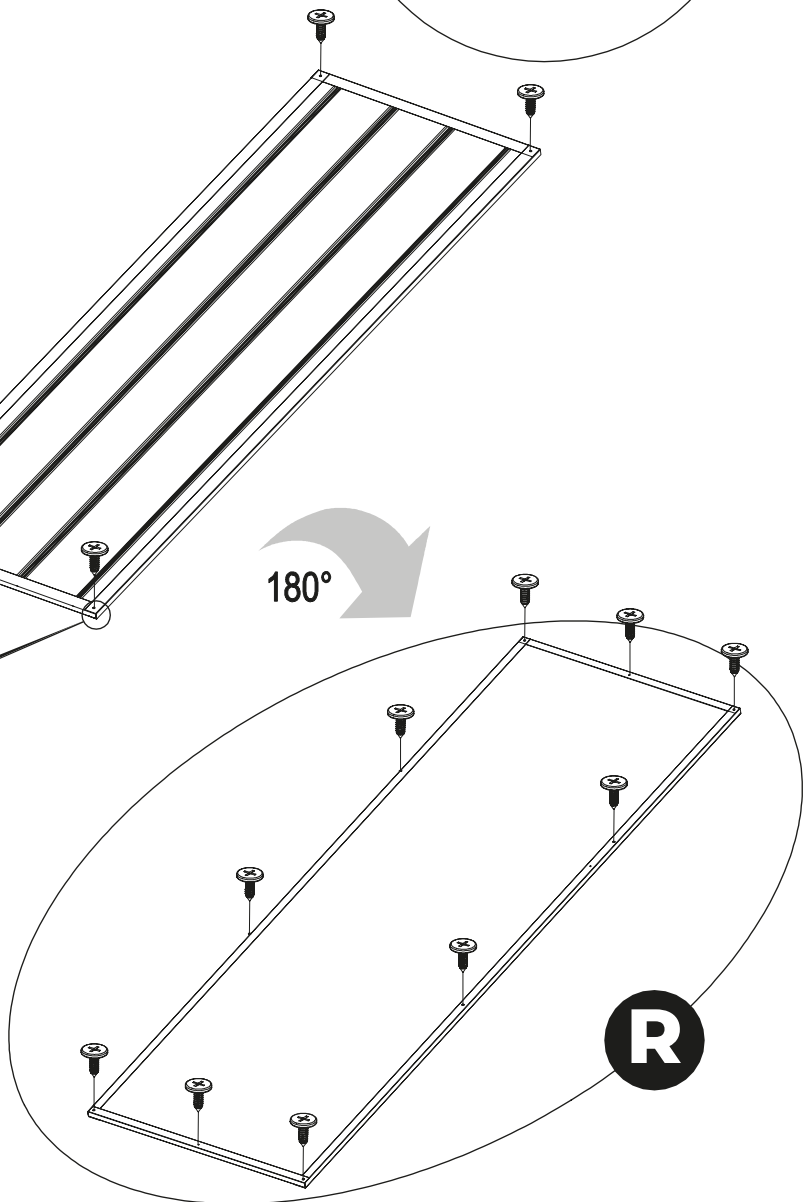
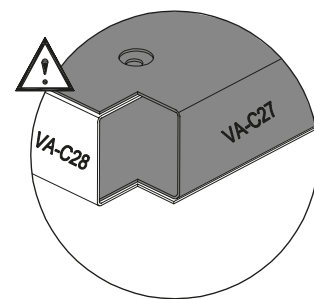
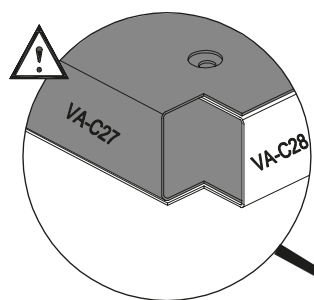
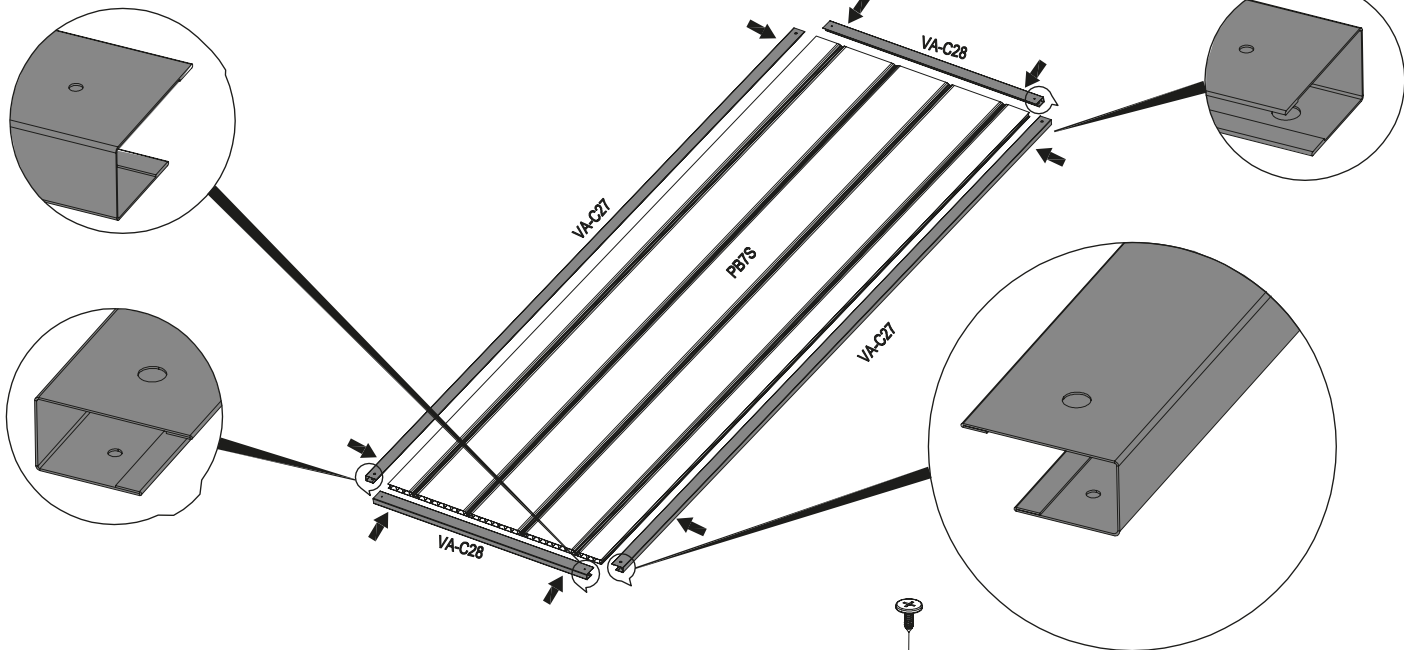

51

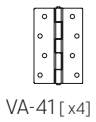

VA-41 [x4]

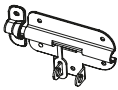

VA-40 [x1]

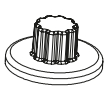

PA01 [x3]



VA-J45 [x3]
19 MM



VA-J44 [x36]
13 MM

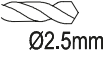

Ø2.5mm

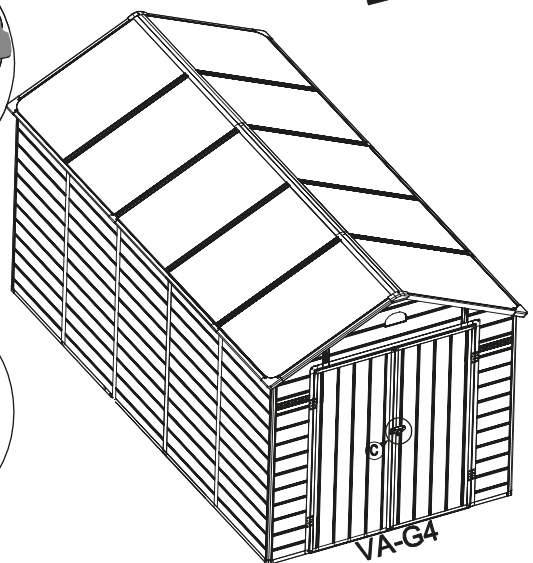
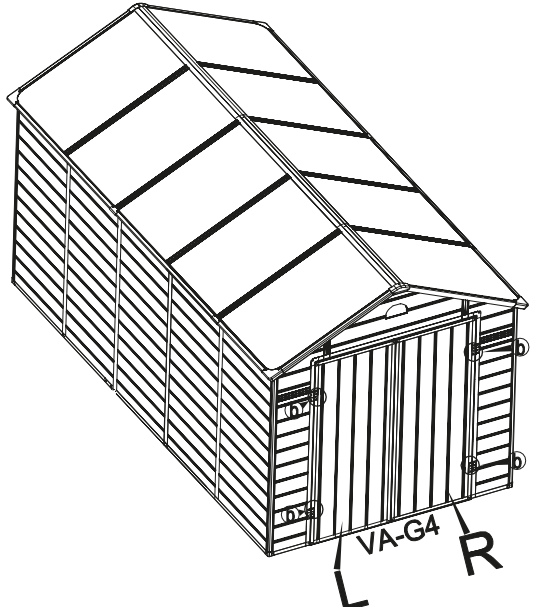
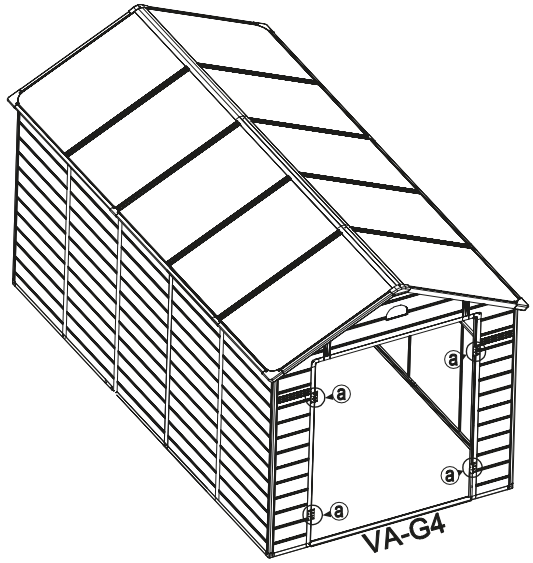
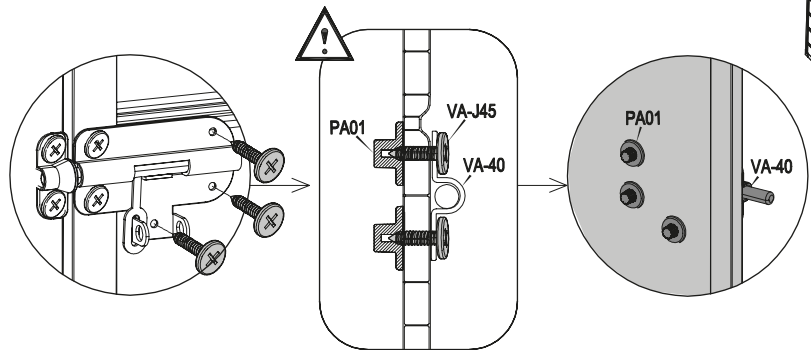
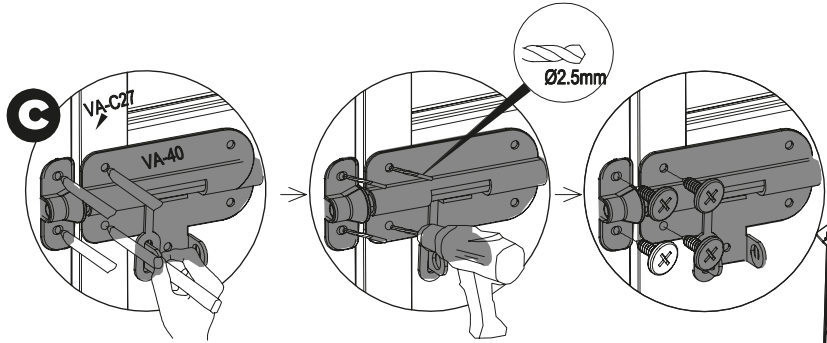
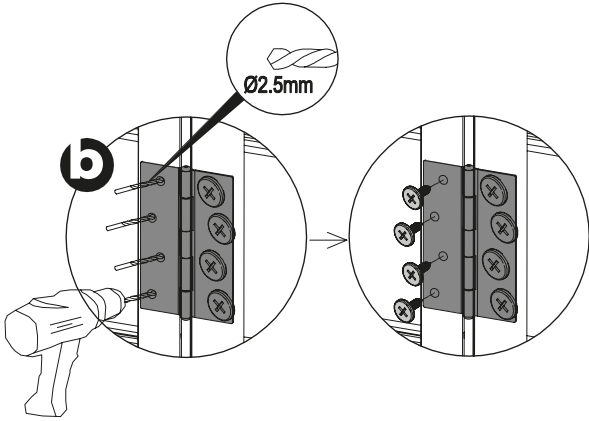
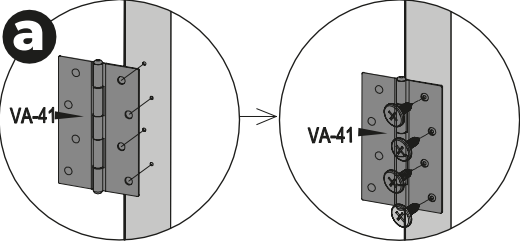

52

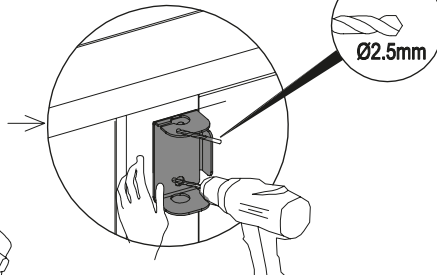
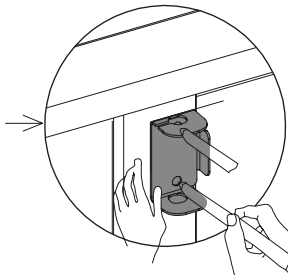
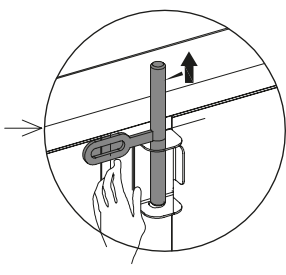
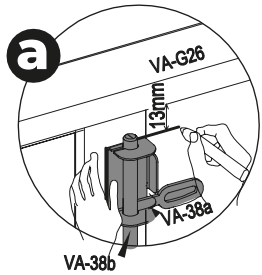
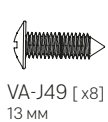
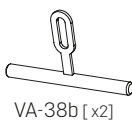

VA-38b

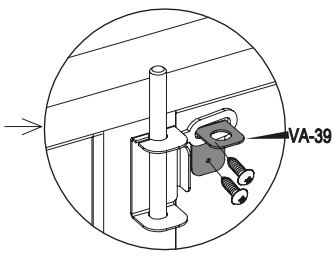
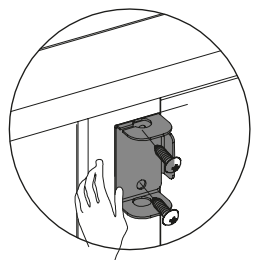

VA-39

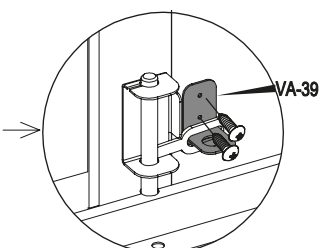
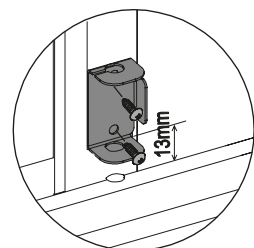
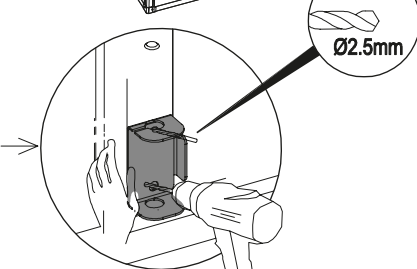
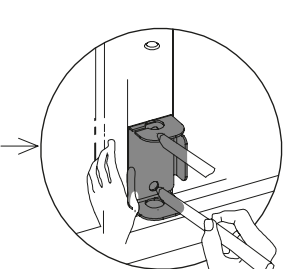
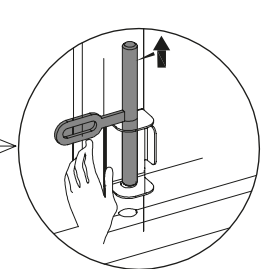
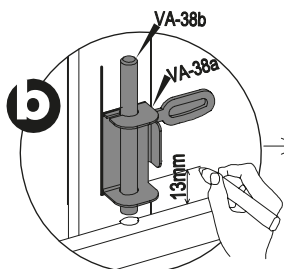
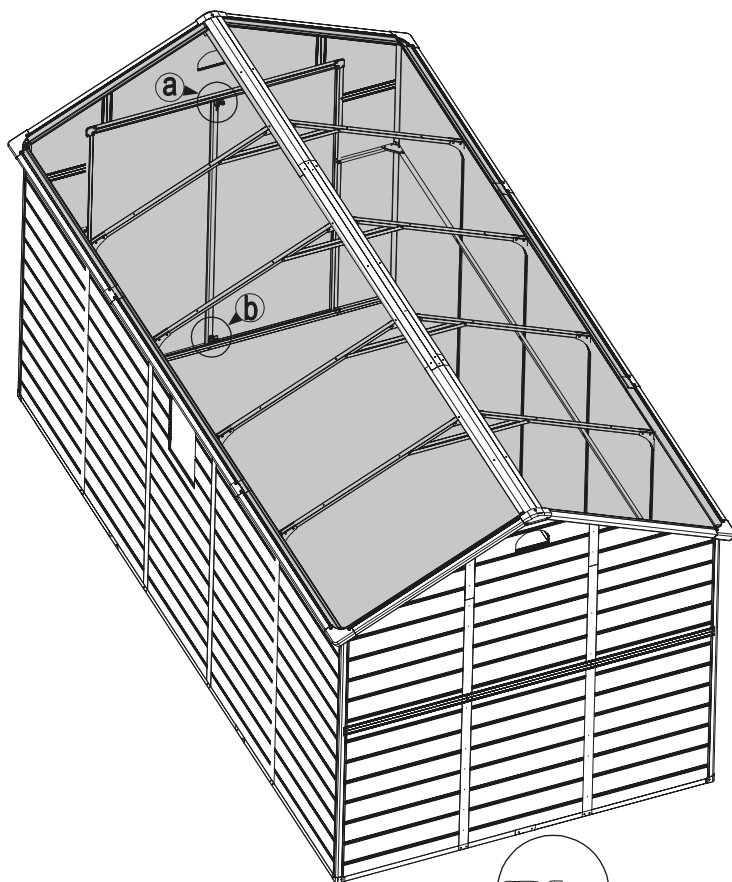

VA-39

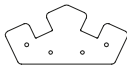

VA-36 [x2]



VA-32L [x2]



VA-32R [x2]



VA-37b [x10]



VA-J44 [x68]
13 MM

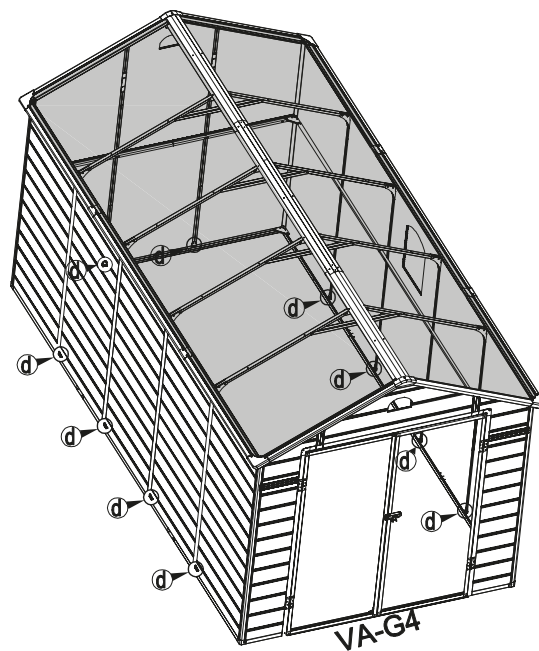
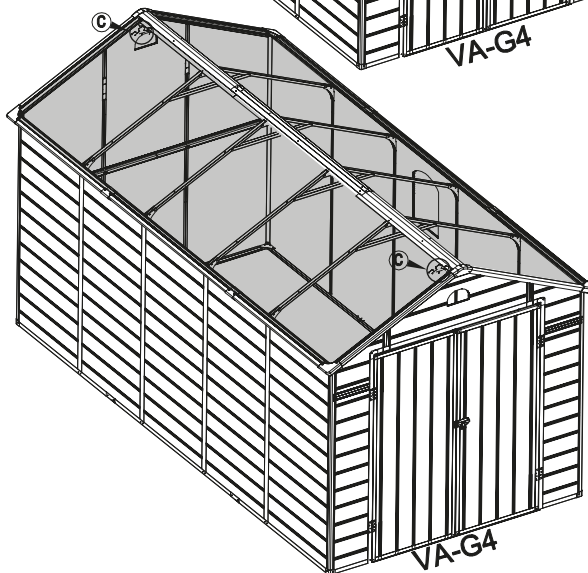
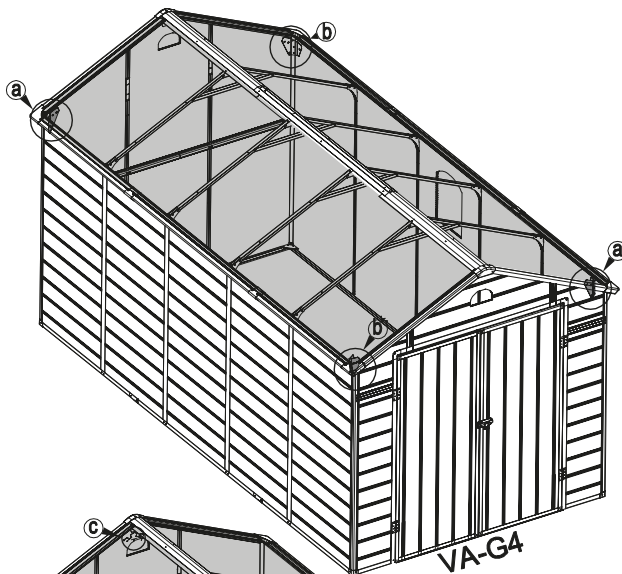
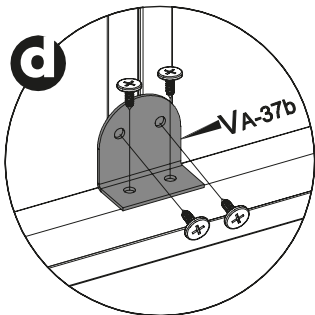
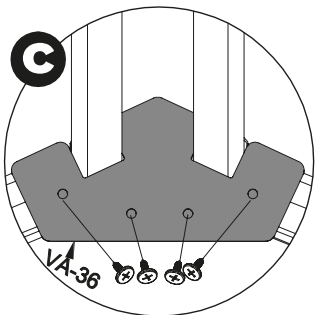
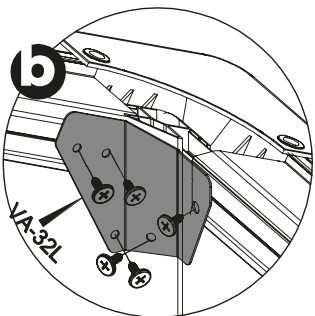
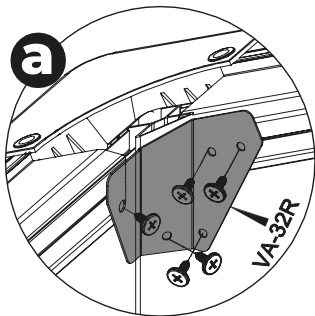

54

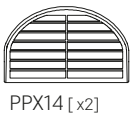

PPX14 [x2]



PPX12 [x1]

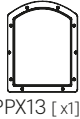

PPX13 [x1]



W2S [x1]



VA-51 [x1]



VA-J44 [x10]
13 MM

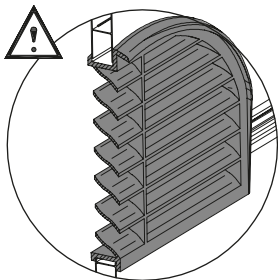

a

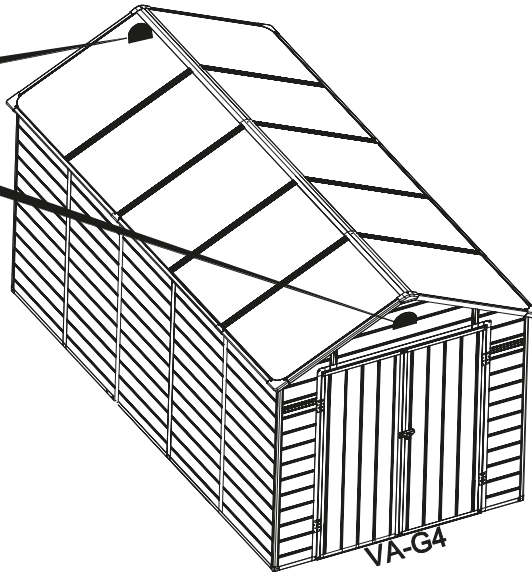
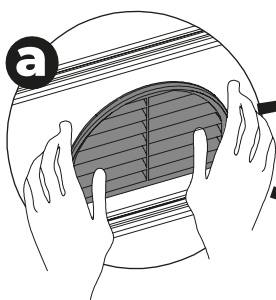

VA-G4

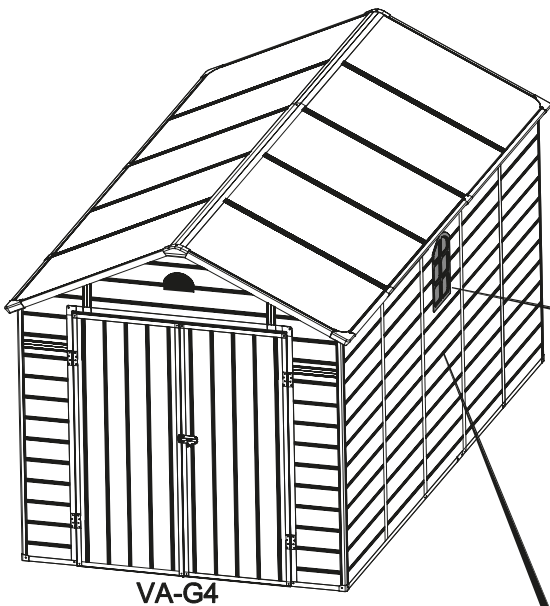

VA-G4

b

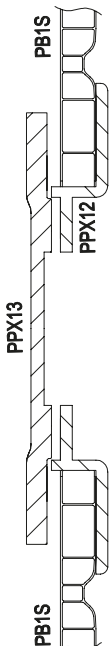
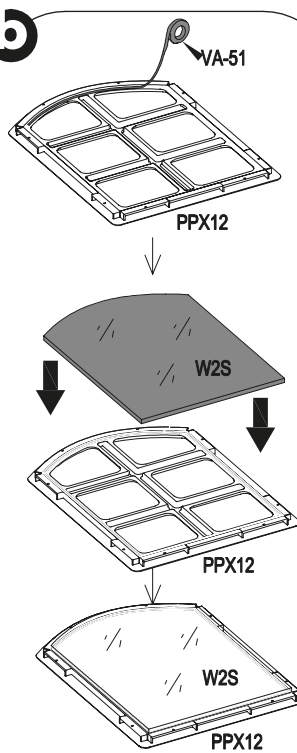

c

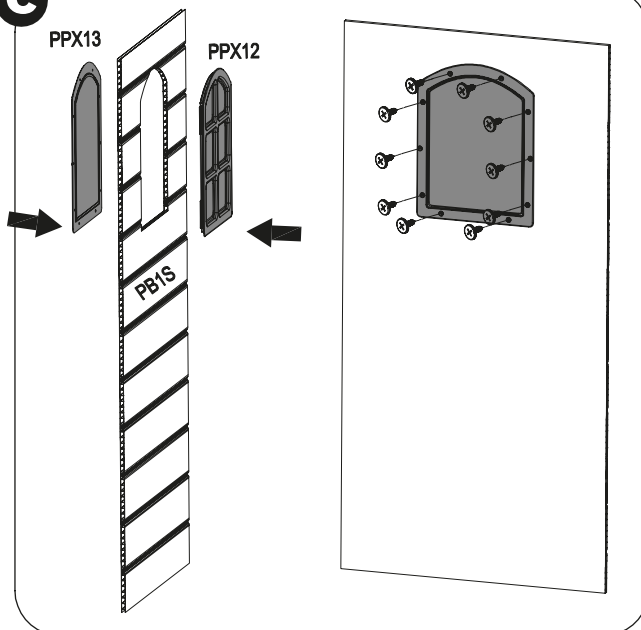

55



VA-DB06 [x2]
880x1102 mm



VA-DB07 [x6]
735x1740 mm



VA-55 [x3]

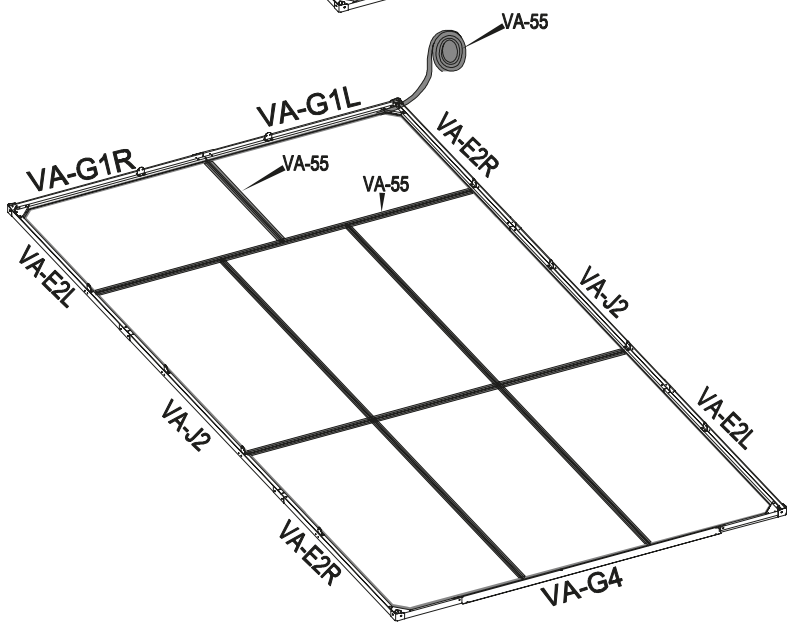
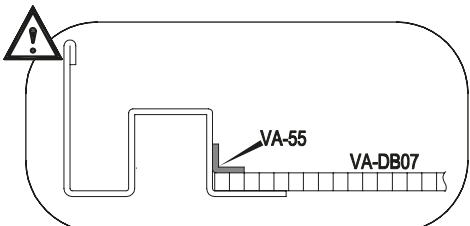
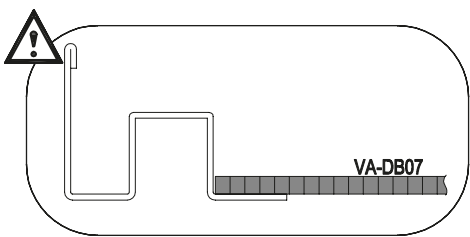
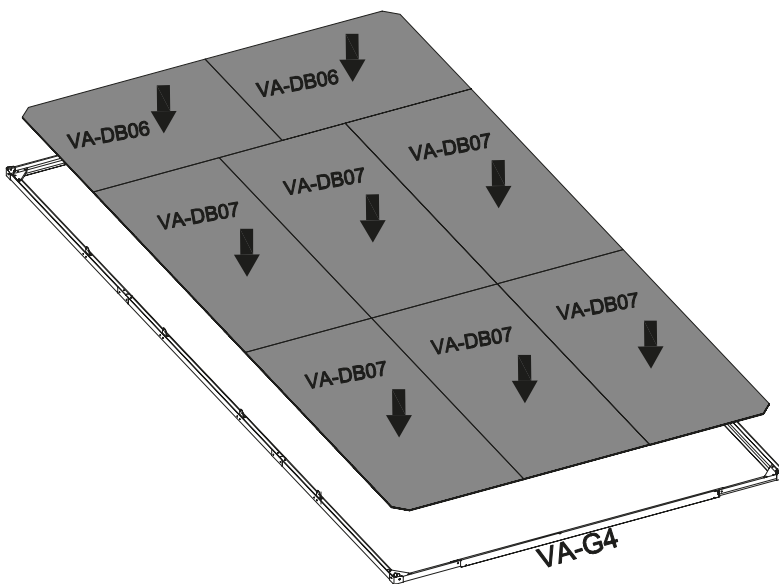
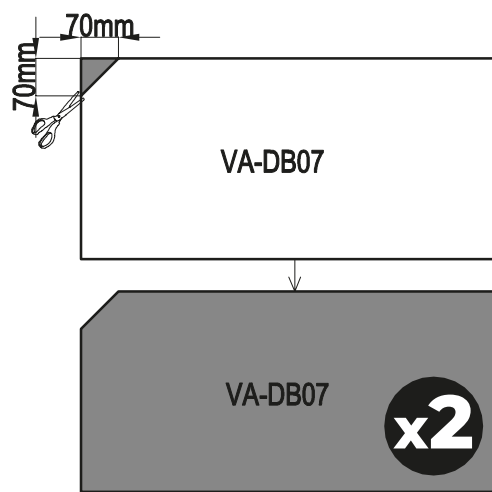
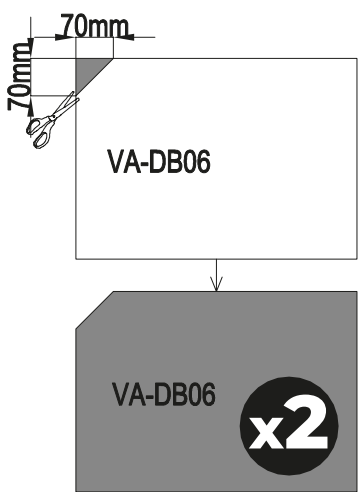

ЭКСПЛУАТАЦИЯ И УХОД

1. Перед началом эксплуатации сарая убедитесь в правильности сборки всех деталей.

2. Очищайте крышу от листьев и снега длинной метлой с мягкой щетиной.

⚠ ВНИМАНИЕ! Большое количества снега на крыше может повредить сарай.

3. Не вставляйте и не наступайте на крышу сарая во время эксплуатации и ухода. Это может привести к повреждению изделия и травмам.

⚠ ВНИМАНИЕ! Не позволяйте детям забираться на крышу сарая! Это не безопасно и может привести к травмам ребенка.

4. Не прислоняйте ничего к панелями стен сарая. Это может повредить изделие.

5. Держите двери закрытыми, чтобы не допустить их повреждения ветром.

6. Регулярно проверяйте все винты, болты, гайки и др. узлы соединения на изделии. Затягивайте их при необходимости.

7. При изменении температуры конденсат может скапливаться внутри сарая. Хорошая вентиляция поможет в регулировании влажности и исключит попадание влаги и порчу вещей.

8. **⚠ ВНИМАНИЕ!** Запрещается хранить химикаты для бассейнов в вашем сарае. Горючие и коррозионные вещества должны храниться в герметичных контейнерах.

9. Не разводите костры и не используйте мангалы и другие приборы с открытым огнем вблизи сарая.

ТРАНСПОРТИРОВКА И ХРАНЕНИЕ

1. Допускается перевозить изделие любым способом, защищая его, его детали и упаковку от повреждений. При выборе способа транспортировки следует учитывать ограничения по удельной нагрузке транспортного средства.

2. Рекомендуется хранить изделие в закрытом отапливаемом или неотапливаемом помещении или под навесом при температуре от -5 до 30°C.

3. Во избежание выгорания поверхности запрещается хранить изделие в условиях прямого попадания солнечного света на детали.

ГАРАНТИЯ ИЗГОТОВИТЕЛЯ

1. Гарантия на изделие 1 год.

2. Гарантийный срок определяется датой отгрузки с завода-изготовителя или датой покупки в магазине. Документом, подтверждающим дату покупки и факт оплаты, является чек.

3. Гарантийное обслуживание осуществляется заводом-изготовителем при предъявлении паспорта изделия и чека, подтверждающего дату продажи.

4. **⚠ ВНИМАНИЕ!** Производитель не несет ответственности и не принимает претензий при несоблюдении условий хранения, транспортировки, сборки, эксплуатации и ухода.

5. **⚠ ВНИМАНИЕ!** Производитель не оплачивает стоимость фундамента, установки и любых других расходов, связанных с транспортировкой, хранением, монтажом и эксплуатацией сарая.

6. Данная гарантия распространяется только на дефекты материала или изготовления, которые могут быть выявлены в процессе сборки или эксплуатации сарая, и не распространяется на изменение цвета, возникающего при обычных погодных условиях, или повреждения, возникающие в результате неправильного обращения или халатности, коммерческого использования, несоблюдения инструкции по сборке и эксплуатации (в том числе по креплению сарая), окраски, природных сил и других причин, которые находятся вне контроля производителя.

7. Изготовитель оставляет за собой право вносить изменения в конструкцию изделия, не ухудшающие его эксплуатационные характеристики, без предварительного уведомления и корректировки данного руководства.

8. Производитель оставляет за собой право прекратить выпуск или изменить компоненты. Если выпуск компонента был прекращен или недоступен, производитель оставляет за собой право заменить его на компонент равного качества, который может быть совместим.

9. **⚠ ВНИМАНИЕ!** Производитель не несет ответственности за вред, причиненный жизни, здоровью или имуществу покупателя (потребителя) в связи с нарушением или не соблюдением покупателем (потребителем) установленных правил эксплуатации (использования), сборки, хранения и транспортировки.